

LRP

Circulation Pump

Application

- It is widely used for heating ventilating and air conditioning (HVAC) circulation, pressure boosting of hot water in family, homes powered by solar energy, industrial auxiliary equipment cold and hot water circulation and so forth
- Water circulation for the central and district heating system
- Domestic hot water circulation

Pump

- Bronze or anti-rust cast iron pump body
- Noryl impeller with heat resistance up to 150°C
- 99% alumina ceramic shaft
- Liquid temperature: 2°C - 110°C

Motor

- Insulation class: H
- Protection class: IP44
- 99% alumina ceramic bearing
- Copper winding
- Three speed motor

Connectors on request

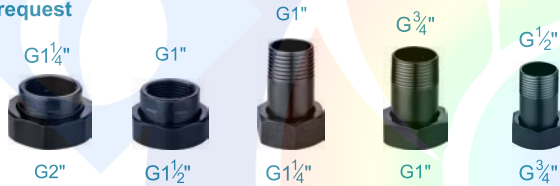

MODEL	A (mm)	B (mm)	C (mm)	D
LRP15-40/130	130	130	125	G1
LRP15-40B/130	130	130	125	G1
LRP20-40/130	130	130	125	G1.25
LRP25-40/130	130	130	125	G1.5
LRP25-40/180	130	180	125	G1.5
LRP32-40/180	135	180	125	G2
LRP15-50/130	130	130	125	G1
LRP15-50B/130	130	130	125	G1
LRP20-50/130	130	130	125	G1.25
LRP25-50/130	130	130	125	G1.5
LRP25-50/180	130	180	125	G1.5
LRP32-50/180	135	180	125	G2
LRP15-60/130	130	130	125	G1
LRP15-60B/130	130	130	125	G1
LRP20-60/130	130	130	125	G1.25
LRP25-60/130	130	130	125	G1.5
LRP25-60/180	130	180	125	G1.5
LRP32-60/180	135	180	125	G2
LRP25-70/130	130	130	125	G1.5
LRP25-70/180	130	180	125	G1.5
LRP32-70/180	135	180	125	G2
LRP25-80/180	154	180	134	G1.5
LRP25-120/180	155	180	148	G1.5
LRP32-80/180	168	180	137	G2

Dimension Drawing

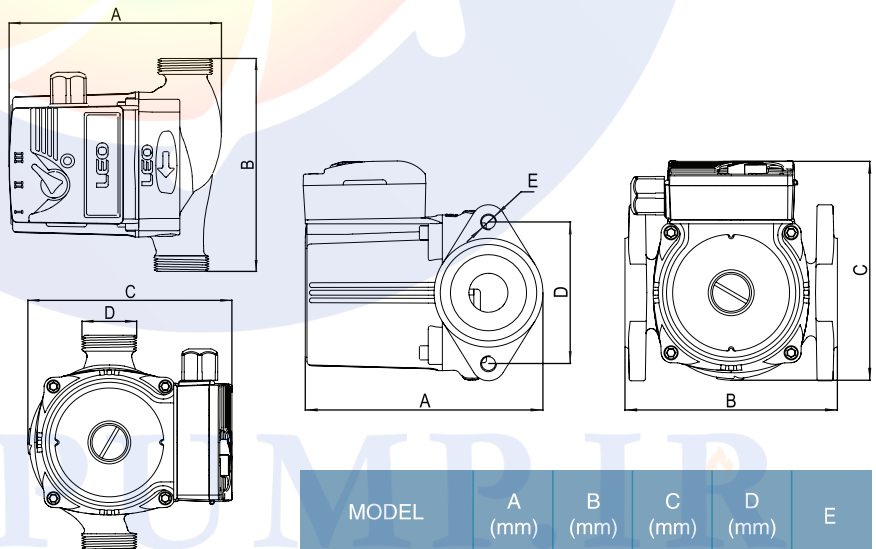

MODEL	A (mm)	B (mm)	C (mm)	D (mm)	E
LRP21-40F/120	130	120	125	80	M10
LRP21-50F/120	130	120	125	80	M10
LRP21-60F/120	130	120	125	80	M10
LRP21-70F/120	130	120	125	80	M10

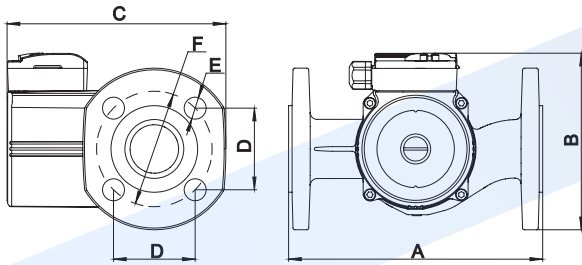

MODEL	A (mm)	B (mm)	C (mm)	D (mm)	E (mm)	F (mm)
LRP32-80F/220	220	150	191.5	70.7	Φ19	Φ100
LRP36-80F/200	200	138	174.5	63.6	Φ11.5	Φ90
LRP40-80F/250	250	155	196.5	77.8	Φ19	Φ110

Identification Codes

LRP 15 - 50 B / 130

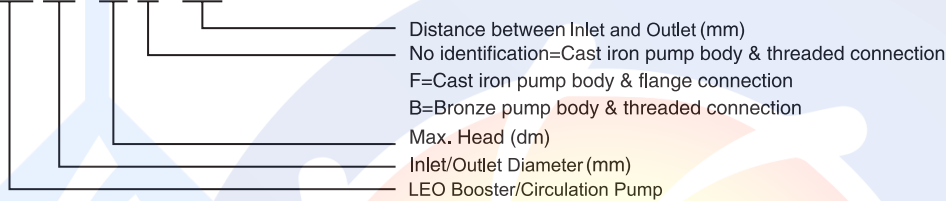

MODEL	POWER	POWER (W)			Max. Flow (l/min)	Max. Head (m)	Inet/Outlet (mm)	Pipe Size (inch)	N.W. (kgs)	G.W. (kgs)	Packing Size (mm)
		3	2	1							
LRP15-40/130	1~230V/50Hz	74	54	34	40/30/22	4.0/3.3/2.3	Φ15	1	2.32	2.45	154x143x153
LRP15-40B/130	1~230V/50Hz	74	54	34	40/30/22	4.0/3.3/2.3	Φ15	1	2.41	2.54	154x143x153
LRP20-40/130	1~230V/50Hz	74	54	34	45/35/25	4.0/3.3/2.3	Φ20	1.25	2.37	2.5	154x143x153
LRP21-40F/120	1~230V/50Hz	74	54	34	55/42/30	4.0/3.3/2.3	Φ21	1.25	2.65	2.78	154x143x153
LRP25-40/130	1~230V/50Hz	74	54	34	52/42/30	4.0/3.3/2.3	Φ25	1.5	2.44	2.57	154x143x153
LRP25-40/180	1~230V/50Hz	74	54	34	55/42/30	4.0/3.3/2.3	Φ25	1.5	2.55	2.705	198x143x160
LRP32-40/180	1~230V/50Hz	74	54	34	55/42/30	4.0/3.3/2.3	Φ32	2	2.73	2.885	198x143x160
LRP15-50/130	1~230V/50Hz	85	60	40	40/32/23	4.5/3.8/2.5	Φ15	1	2.32	2.45	154x143x153
LRP15-50B/130	1~230V/50Hz	85	60	40	40/32/23	4.5/3.8/2.5	Φ15	1	2.41	2.54	154x143x153
LRP20-50/130	1~230V/50Hz	85	60	40	47/37/25	4.5/3.8/2.5	Φ20	1.25	2.37	2.5	154x143x153
LRP21-50F/120	1~230V/50Hz	85	60	40	58/45/32	4.5/3.8/2.5	Φ21	1.25	2.65	2.78	154x143x153
LRP25-50/130	1~230V/50Hz	85	60	40	55/43/28	4.5/3.8/2.5	Φ25	1.5	2.44	2.57	154x143x153
LRP25-50/180	1~230V/50Hz	85	60	40	60/47/32	4.5/3.8/2.5	Φ25	1.5	2.55	2.705	198x143x160
LRP32-50/180	1~230V/50Hz	85	60	40	60/47/32	4.5/3.8/2.5	Φ32	2	2.73	2.885	198x143x160
LRP15-60/130	1~230V/50Hz	96	69	45	40/32/23	5.5/4.5/2.8	Φ15	1	2.32	2.45	154x143x153
LRP15-60B/130	1~230V/50Hz	96	69	45	40/32/23	5.5/4.5/2.8	Φ15	1	2.41	2.54	154x143x153
LRP20-60/130	1~230V/50Hz	96	69	45	53/37/25	5.5/4.5/2.8	Φ20	1.25	2.37	2.5	154x143x153
LRP21-60F/120	1~230V/50Hz	96	69	45	60/45/32	5.5/4.5/2.8	Φ21	1.25	2.65	2.78	154x143x153
LRP25-60/130	1~230V/50Hz	96	69	45	58/43/28	5.5/4.5/2.8	Φ25	1.5	2.44	2.57	154x143x153
LRP25-60/180	1~230V/50Hz	96	69	45	66/47/32	5.5/4.5/2.8	Φ25	1.5	2.55	2.705	198x143x160
LRP32-60/180	1~230V/50Hz	96	69	45	66/47/32	5.5/4.5/2.8	Φ32	2	2.73	2.885	198x143x160
LRP21-70F/120	1~230V/50Hz	150	130	105	67/50/37	6.3/6.0/5.2	Φ21	1.5	2.65	2.805	154x143x153
LRP25-70/130	1~230V/50Hz	150	130	105	67/50/37	6.3/6.0/5.2	Φ25	1.5	2.45	2.605	154x143x153
LRP25-70/180	1~230V/50Hz	150	130	105	67/50/37	6.3/6.0/5.2	Φ25	1.5	2.57	2.725	198x143x160
LRP32-70/180	1~230V/50Hz	150	130	105	67/50/34	6.3/6.0/5.2	Φ32	2	2.75	2.905	198x143x160
LRP25-80/180	1~230V/50Hz	200	190	160	120/100/60	7.1/6.5/5.5	Φ28	1.5	4.23	4.57	192x170x190
LRP32-80/180	1~230V/50Hz	270	245	160	167/100/60	7.3/6.7/5.4	Φ42	2	4.75	5.09	192x170x190
LRP32-80F/220	1~230V/50Hz	270	245	160	170/113/65	7.3/6.7/5.4	Φ42	2	7.57	8	235x181x207
LRP36-80F/200	1~230V/50Hz	270	245	160	170/113/65	7.3/6.7/5.4	Φ42	2	5.98	6.36	214x170x190
LRP40-80F/250	1~230V/50Hz	270	245	160	170/113/65	7.3/6.7/5.4	Φ42	2	8.27	8.74	264x186x212
LRP25-120/180	1~230V/50Hz	270	245	160	67/38/22.5	11.5/10/6.3	Φ18	1.5	4.62	4.96	192x170x190

Hydraulic Performance Curves

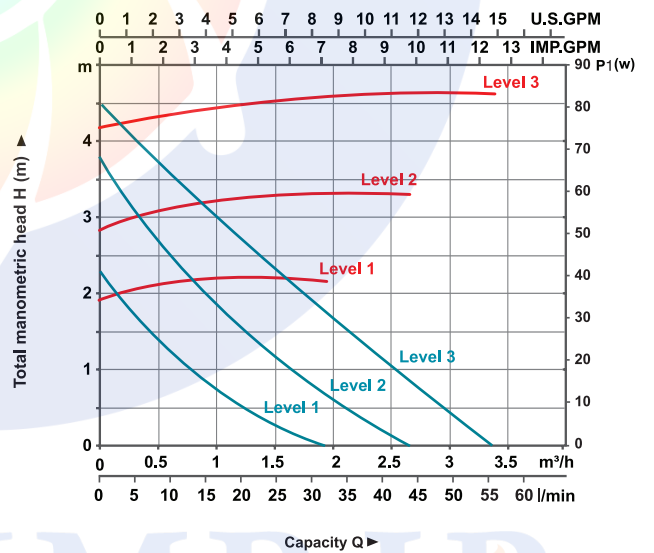
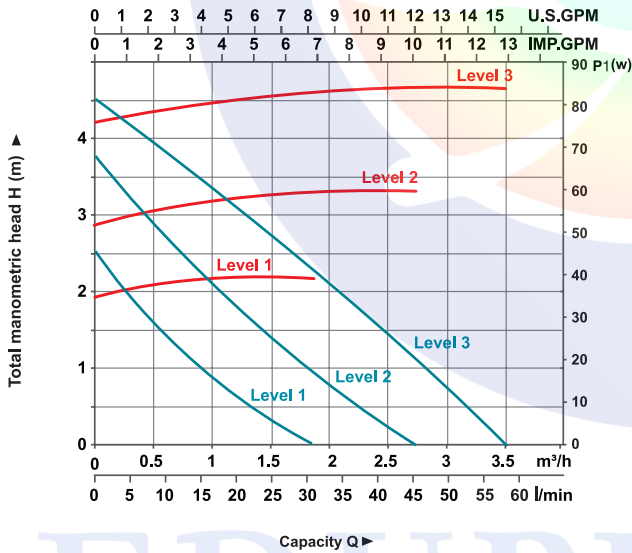
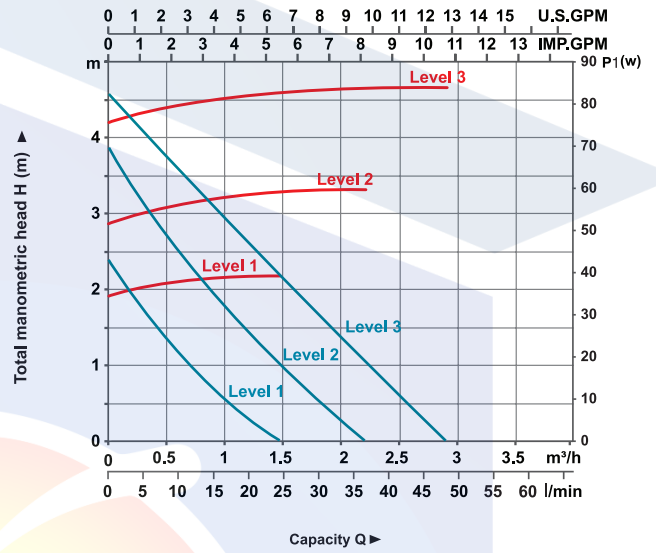
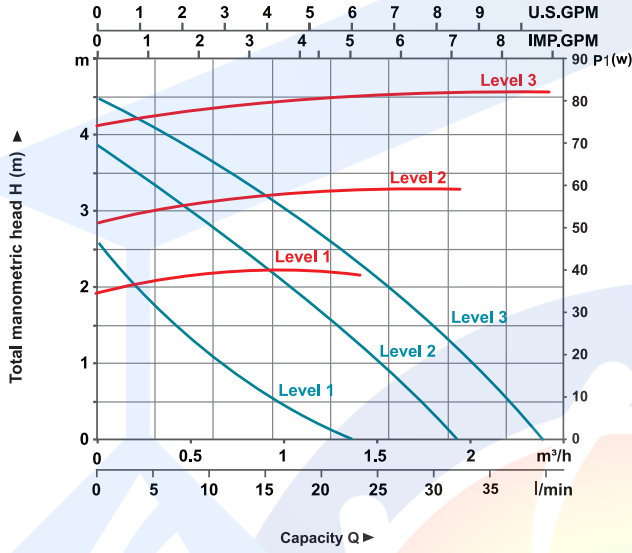

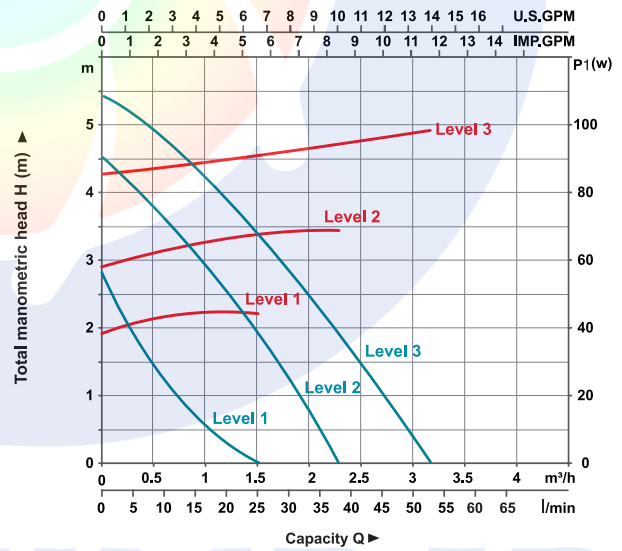
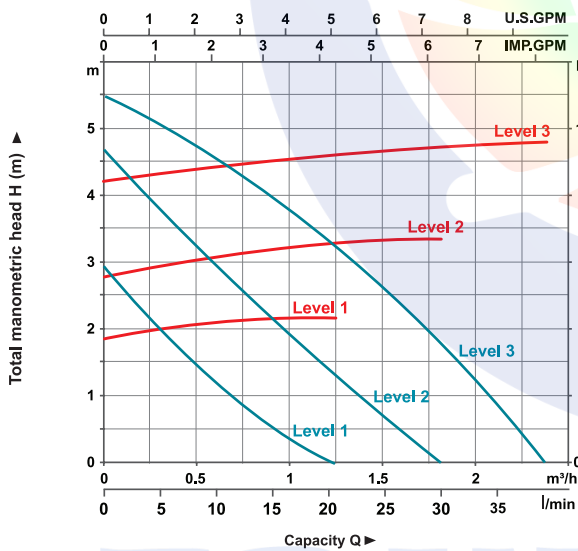
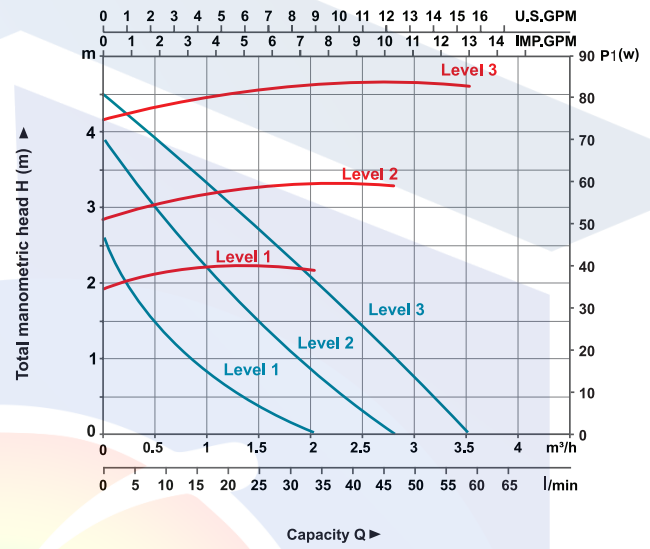
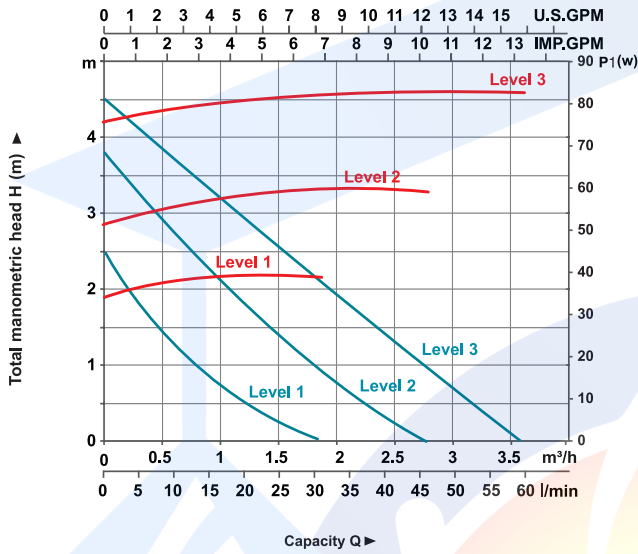



EDUPUMP
WWW.EDUPUMP.IR

اولین و بزرگترین

سایت تخصصی سیستم‌های پمپاژ
با امکان محاسبه آنلاین و انتخاب پمپ

تولید بوستر پمپ آتش نشانی

در کلاس‌های S3 - S2 - S1
مورد تایید سازمان آتش نشانی تهران



اولین و بزرگترین مرجع انتخاب آنلاین سیستم‌های پمپاژ

انتخاب آنلاین انواع بوستر پمپ

انتخاب آنلاین انواع پمپ

ارائه مطالب تخصصی

اولین سایت مرجع

انتخاب آنلاین پمپ

در حوزه‌های:

ایمنی و آتش نشانی
آب و فاضلاب
صنایع غذایی
استخر
صنعت
معدن



تولید بوستر پمپ

آبرسانی دور متغیر

بدون محدودیت برند



آموزش

تهویه و تخلیه دود
سیستم‌های پمپاژ
ایمنی معماری
اطفاء حریق
اعلام حریق

مشاوره - طراحی - اجراء

تاسیسات مکانیکی (موتورخانه - استخر)
تهویه و تخلیه دود
سیستم‌های پمپاژ
ایمنی معماری
اعلام حریق
اطفاء حریق

تهران، سعدی شمالی، خیابان مرادی نور، پلاک ۳۱

تلفن: ۰۲۱-۷۷۶۸۶۹۶۶ فکس: ۰۲۱-۷۷۶۷۸۶۵۹

EDUPUMP.IR

WWW.EDUPUMP.IR