

Series description: Wilo-VeroLine-IPL

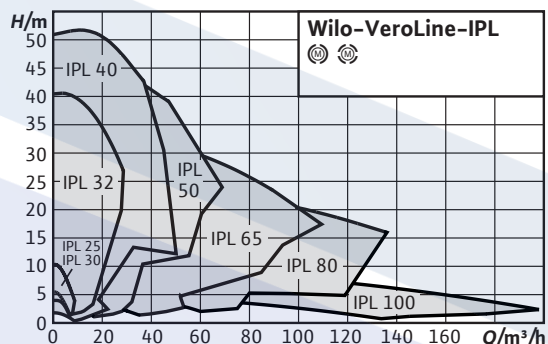

Design

Glanded pump in in-line design with threaded connection or flange connection

Application

For pumping heating water (in accordance with VDI 2035), water-glycol mixtures and cooling and cold water without abrasive substances in heating, cold water and cooling water systems

Type key

Example	IPL 40/1604/2
IPL	In-line pump
40	Nominal diameter DN of the pipe connection
160	Nominal impeller diameter
4	Nominal motor power P_2 in kW
2	Number of poles

Special features/product advantages

- High-efficiency motors as standard; from 0.75 kW nominal motor power: motors with IE2 technology
- High corrosion protection thanks to cataphoretic coating
- Standard condensate drainage holes in the motor housings and lanterns
- Series version: Motor with one-piece shaft
- Version N: Standard motor B5 or V1 with stainless steel plug shaft
- Bidirectional mechanical seal with forced flushing
- Easy to install due to feet with threaded holes on pump housing

Technical data

- Permissible temperature range -20 °C to $+120\text{ °C}$
- Mains connection 3~400 V, 50 Hz (others on request)
- Protection class IP 55
- Nominal diameter Rp 1 to DN 100
- Max. operating pressure 10 bar (special version: 16 bar)

Description/design

Single-stage, low-pressure centrifugal pump in in-line design with

- Mechanical seal
- Flange connection with pressure measuring connection $R\frac{1}{8}$
- Motor with one-piece shaft

Materials

- Pump housing and lantern: EN-GJL-250
- Impeller: PPO fibreglass-reinforced ENGJL200 (depending on pump type)
- Shaft: 1.4021
- Mechanical seal: AQEGG; other mechanical seals on request

Scope of delivery

- Pump
- Installation and operating instructions

Options

- Available in following designs as standard
- with 2-pole motors 3~400 V ($n = 2900\text{ rpm}$)
 - with 4-pole motors 3~400 V ($n = 1450\text{ rpm}$)

Accessories

- Brackets for installation on a base
- PTC thermistor sensors, PTC resistor tripping relays, special motors
- Special mechanical seals
- Control systems CR, CRn, CC-HVAC, VR-HVAC and switchgears

General notes – ErP (ecological design-) directive

- The benchmark for most efficient water pumps is $MEI \geq 0.70$
- The efficiency of a pump with a trimmed impeller is usually lower than that of a pump with the full impeller diameter. The trimming of the impeller will adapt the pump to a fixed duty point, leading to reduced energy consumption. The minimum efficiency index (MEI) is based on the full impeller diameter.
- The operation of this water pump with variable duty points may be more efficient and economic when controlled, for example, by the use of a variable speed drive that matches the pump duty to the system.
- Information on benchmark efficiency is available at www.europump.org/efficiencycharts

EDUPUMP.IR

Data sheet: Wilo-VeroLine-IPL 50/155-4/2

Pump curves

2-pole, 50 Hz

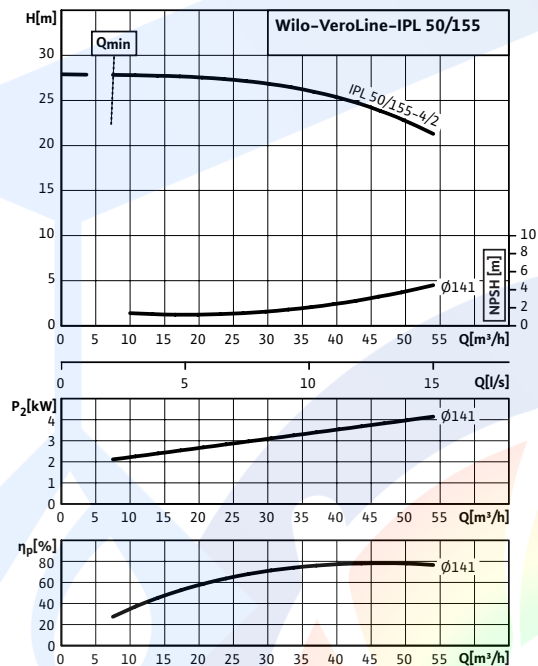

Dimension drawing

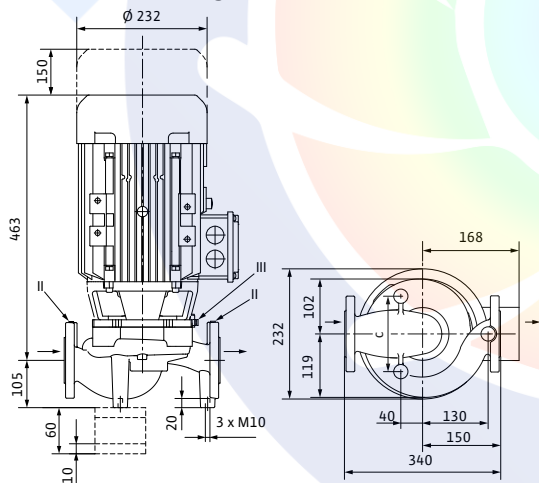

Approved fluids (other fluids on request)

Heating water (in accordance with VDI 2035)	•
Water-glycol mixtures (for 20–40 vol.% glycol and fluid temperature ≤ 40 °C)	•
Cooling and cold water	•
Heat transfer oil	Special version at additional charge

Permitted field of application

Standard version for operating pressure	p_{max}	10 bar
Temperature range at max. ambient temperature +40 °C		-20...+120 °C
Max. ambient temperature		40 °C
Installation in closed buildings		•

Pipe connections

Nominal flange diameter		DN 50
Flanges (according to EN 1092-2)		PN 10 (PN 16 on request)
Flange with pressure-measurement connections		R 1/8

Materials

Pump housing		EN-GJL-250
Lantern		EN-GJL-250
Impeller		EN-GJL-200
Pump shaft		1.4021
Mechanical seal		AQEGG

Electrical connection

Nominal speed	n	2900 rpm
---------------	-----	----------

Motor/electronics

Minimum Efficiency Index (MEI)		≥ 0.1
Protection class		IP 55
Insulation class		F
Nominal current (approx.)	I_N	7.70 A
	3~40	
	0 V	
Efficiency	η_M	0.858
Power factor	$\cos \varphi$	0.87

Data sheet: Wilo-VeroLine-IPL 50/155-4/2

Dimension drawing, flange

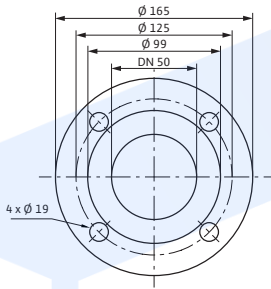

Terminal diagram Star switching Y

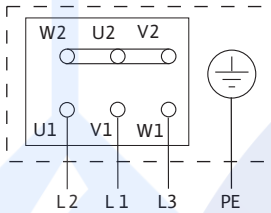

Terminal diagram Delta switching Δ

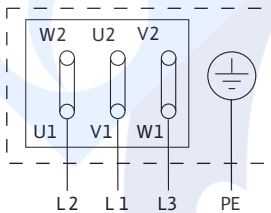

Motor protection switch required onsite. Check the direction of rotation! To change the direction of rotation, swap any two phases.

$P_2 \leq 3 \text{ kW}$	3~400 V Y
	3~230 V Δ
$P_2 \geq 4 \text{ kW}$	3~690 V Y
	3~400 V Δ

After removing the bridges, a Y-Δ start is possible.

Motor efficiency	η_m	83.7/86.3/85.8 %
	$\frac{50\%}{m} / \frac{75\%}{m} / \frac{100\%}{m}$	
Nominal motor power	P_2	4 kW

Installation options

Pipe installation ($\leq 15 \text{ kW}$ motor power)

Information for order placements

Weight approx.	m	63.20 kg
Make		Wilo
Type		VeroLine-IPL 50/155-4/2
Art no.		2089598

Observe motor name plate data



EDUPUMP
WWW.EDUPUMP.IR

اولین و بزرگترین

سایت تخصصی سیستم‌های پمپاژ
با امکان محاسبه آنلاین و انتخاب پمپ

تولید بوستر پمپ آتش نشانی

در کلاس‌های S3 - S2 - S1
مورد تایید سازمان آتش نشانی تهران



اولین و بزرگترین مرجع انتخاب آنلاین سیستم‌های پمپاژ

انتخاب آنلاین انواع بوستر پمپ

انتخاب آنلاین انواع پمپ

ارائه مطالب تخصصی

اولین سایت مرجع

انتخاب آنلاین پمپ

در حوزه‌های:

ایمنی و آتش نشانی
آب و فاضلاب
صنایع غذایی
استخر
صنعت
معدن

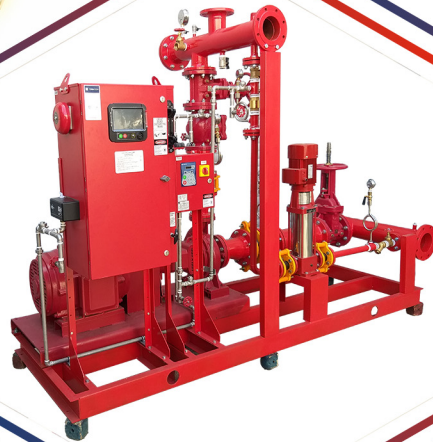

تولید بوستر پمپ

آبرسانی دور متغیر

بدون محدودیت برند



آموزش

تهویه و تخلیه دود
سیستم‌های پمپاژ
ایمنی معماری
اطفاء حریق
اعلام حریق

مشاوره - طراحی - اجراء

تاسیسات مکانیکی (موتورخانه - استخر)
تهویه و تخلیه دود
سیستم‌های پمپاژ
ایمنی معماری
اعلام حریق
اطفاء حریق

تهران، سعدی شمالی، خیابان مرادی نور، پلاک ۳۱

تلفن: ۰۲۱-۷۷۶۸۶۹۶۶ فکس: ۰۲۱-۷۷۶۷۸۶۵۹

EDUPUMP.IR

WWW.EDUPUMP.IR