

## Series description: Wilo-VeroLine-IPL

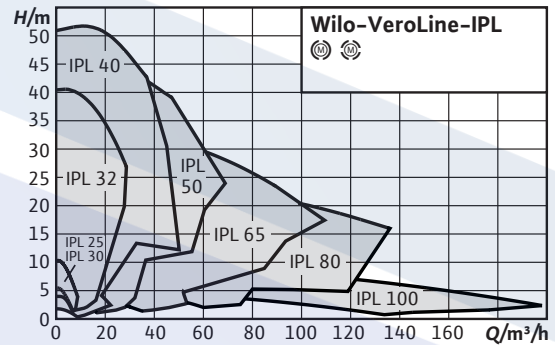

### Design

Glanded pump in in-line design with threaded connection or flange connection

### Application

For pumping heating water (in accordance with VDI 2035), water-glycol mixtures and cooling and cold water without abrasive substances in heating, cold water and cooling water systems

### Type key

Example	IPL 40/1604/2
<b>IPL</b>	In-line pump
<b>40</b>	Nominal diameter DN of the pipe connection
<b>160</b>	Nominal impeller diameter
<b>4</b>	Nominal motor power $P_2$ in kW
<b>2</b>	Number of poles

### Special features/product advantages

- High-efficiency motors as standard; from 0.75 kW nominal motor power: motors with IE2 technology
- High corrosion protection thanks to cataphoretic coating
- Standard condensate drainage holes in the motor housings and lanterns
- Series version: Motor with one-piece shaft
- Version N: Standard motor B5 or V1 with stainless steel plug shaft
- Bidirectional mechanical seal with forced flushing
- Easy to install due to feet with threaded holes on pump housing

### Technical data

- Permissible temperature range  $-20\text{ °C}$  to  $+120\text{ °C}$
- Mains connection 3~400 V, 50 Hz (others on request)
- Protection class IP 55
- Nominal diameter Rp 1 to DN 100
- Max. operating pressure 10 bar (special version: 16 bar)

### Description/design

Single-stage, low-pressure centrifugal pump in in-line design with

- Mechanical seal
- Flange connection with pressure measuring connection  $R\frac{1}{8}$
- Motor with one-piece shaft

### Materials

- Pump housing and lantern: EN-GJL-250
- Impeller: PPO fibreglass-reinforced ENGJL200 (depending on pump type)
- Shaft: 1.4021
- Mechanical seal: AQEGG; other mechanical seals on request

### Scope of delivery

- Pump
- Installation and operating instructions

### Options

- Available in following designs as standard
- with 2-pole motors 3~400 V ( $n = 2900\text{ rpm}$ )
  - with 4-pole motors 3~400 V ( $n = 1450\text{ rpm}$ )

### Accessories

- Brackets for installation on a base
- PTC thermistor sensors, PTC resistor tripping relays, special motors
- Special mechanical seals
- Control systems CR, CRn, CC-HVAC, VR-HVAC and switchgears

### General notes – ErP (ecological design-) directive

- The benchmark for most efficient water pumps is  $MEI \geq 0.70$
- The efficiency of a pump with a trimmed impeller is usually lower than that of a pump with the full impeller diameter. The trimming of the impeller will adapt the pump to a fixed duty point, leading to reduced energy consumption. The minimum efficiency index (MEI) is based on the full impeller diameter.
- The operation of this water pump with variable duty points may be more efficient and economic when controlled, for example, by the use of a variable speed drive that matches the pump duty to the system.
- Information on benchmark efficiency is available at [www.europump.org/efficiencycharts](http://www.europump.org/efficiencycharts)

EDUPUMP.IR

## Data sheet: Wilo-VeroLine-IPL 32/110-0.75/2

### Pump curves

2-pole, 50 Hz

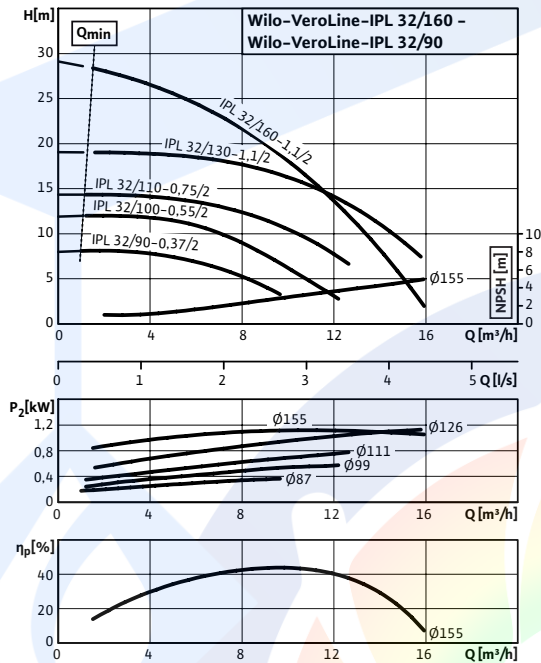

### Dimension drawing

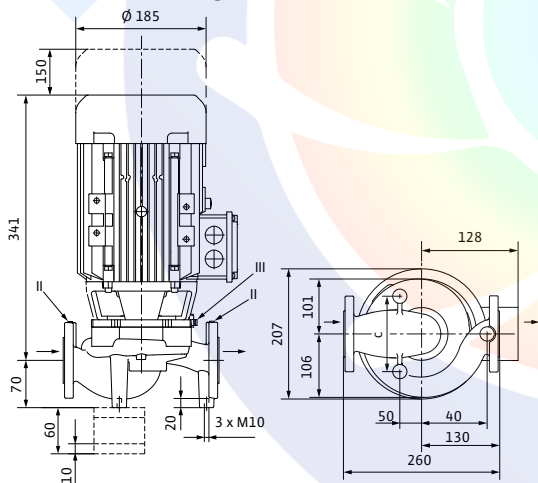

### Approved fluids (other fluids on request)

Heating water (in accordance with VDI 2035)	•
Water-glycol mixtures (for 20-40 vol.% glycol and fluid temperature ≤ 40 °C)	•
Cooling and cold water	•
Heat transfer oil	Special version at additional charge

### Permitted field of application

Standard version for operating pressure	$p_{max}$	10 bar
Temperature range at max. ambient temperature +40 °C		-20...+120 °C
Max. ambient temperature		40 °C
Installation in closed buildings		•

### Pipe connections

Nominal flange diameter		DN 32
Flanges (according to EN 1092-2)		PN 10 (PN 16 on request)
Flange with pressure-measurement connections		R 1/8

### Materials

Pump housing		EN-GJL-250
Lantern		EN-GJL-250
Impeller		PPO-GF30
Pump shaft		1.4021
Mechanical seal		AQEGG

### Electrical connection

Mains connection		3~400 V, 50 Hz
Nominal speed	$n$	2900 rpm

### Motor/electronics

Minimum Efficiency Index (MEI)		≥ 0.1
Integrated full motor protection		Special version with PTC thermistor sensor (KLF) at additional charge
Protection class		IP 55
Insulation class		F
Nominal current (approx.)	$I_N$ 3~40 0 V	1.70 A
Efficiency	$\eta_M$	0.774

## Data sheet: Wilo-VeroLine-IPL 32/110-0.75/2

### Dimension drawing, flange

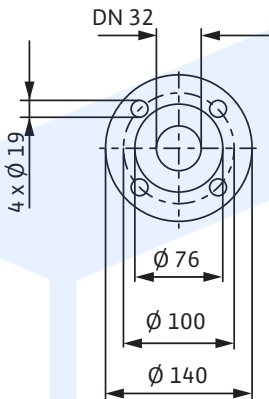

### Terminal diagram Star switching Y

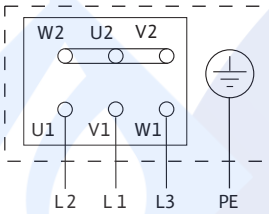

### Terminal diagram Delta switching $\Delta$

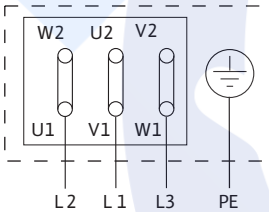

Motor protection switch required onsite. Check the direction of rotation! To change the direction of rotation, swap any two phases.

$P_2 \leq 3 \text{ kW}$	3~400 V Y
	3~230 V $\Delta$
$P_2 \geq 4 \text{ kW}$	3~690 V Y
	3~400 V $\Delta$

After removing the bridges, a Y- $\Delta$  start is possible.

Power factor	$\cos \varphi$	0.81
Motor efficiency	$\eta_m$ 50% 75% m 100%	75.1/77.4/77.4 %
Nominal motor power	$P_2$	0.75 kW

### Installation options

Pipe installation ( $\leq 15 \text{ kW}$  motor power)

### Information for order placements

Weight approx.	$m$	25.50 kg
Make	Wilo	
Type	VeroLine-IPL 32/110-0.75/2	
Art no.	2089579	

Observe motor name plate data



**EDUPUMP**  
WWW.EDUPUMP.IR

## اولین و بزرگترین

سایت تخصصی سیستم‌های پمپاژ  
با امکان محاسبه آنلاین و انتخاب پمپ

## تولید بوستر پمپ آتش نشانی

در کلاس‌های S3 - S2 - S1  
مورد تایید سازمان آتش نشانی تهران



اولین و بزرگترین مرجع انتخاب آنلاین سیستم‌های پمپاژ

انتخاب آنلاین انواع بوستر پمپ

انتخاب آنلاین انواع پمپ

ارائه مطالب تخصصی

## اولین سایت مرجع

## انتخاب آنلاین پمپ

در حوزه‌های:

ایمنی و آتش نشانی  
آب و فاضلاب  
صنایع غذایی  
استخر  
صنعت  
معدن

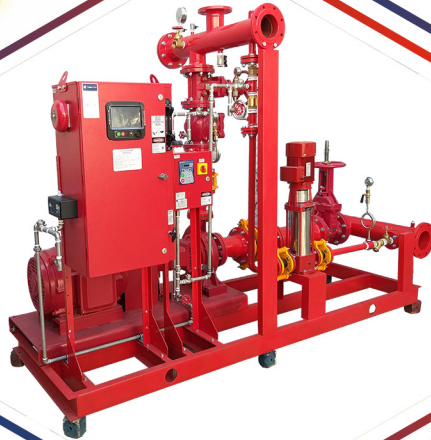

## تولید بوستر پمپ

## آبرسانی دور متغیر

بدون محدودیت برند



## آموزش

تهویه و تخلیه دود  
سیستم‌های پمپاژ  
ایمنی معماری  
اطفاء حریق  
اعلام حریق

## مشاوره - طراحی - اجراء

تاسیسات مکانیکی (موتورخانه - استخر)  
تهویه و تخلیه دود  
سیستم‌های پمپاژ  
ایمنی معماری  
اعلام حریق  
اطفاء حریق

تهران، سعدی شمالی، خیابان مرادی نور، پلاک ۳۱

تلفن: ۰۲۱-۷۷۶۸۶۹۶۶ فکس: ۰۲۱-۷۷۶۷۸۶۵۹

EDUPUMP.IR

WWW.EDUPUMP.IR