

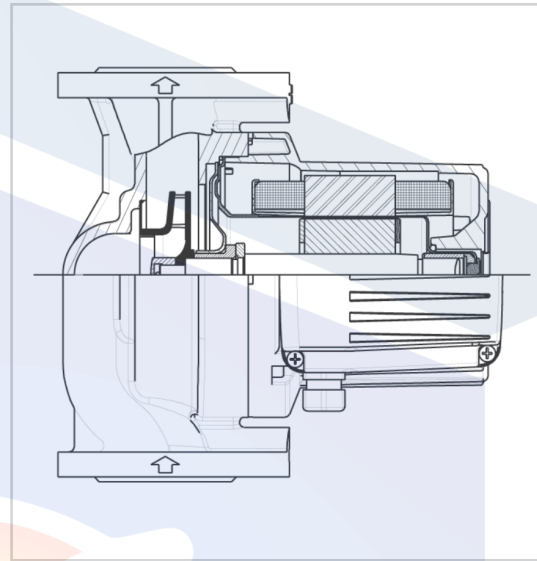

# GHN PUMPS

## TECHNICAL DATA

## GHNbasic II pumps



| Material         |                            |
|------------------|----------------------------|
| Hydraulic casing | cast iron cataphoresis     |
| Impeller         | stainless steel - AISI 316 |
| Shaft            | stainless steel - AISI 316 |
| Bearings         | graphite                   |
| Rotor can        | stainless steel - AISI 316 |

| Technical specification |                           |
|-------------------------|---------------------------|
| Q                       | 10 - 75 m <sup>3</sup> /h |
| H                       | 3,5 - 19,5 m              |
| P                       | PN 6/10; PN6; PN10        |
| DN                      | 40/50/65/80/100           |
| Pipe connection         | 250/280/340/360 mm        |
| Installation            | flange                    |
| Insulation class        | 200                       |
| Degree of protection    | IP 43                     |
| Voltage                 | 3 ~ 400V                  |

### Performance range

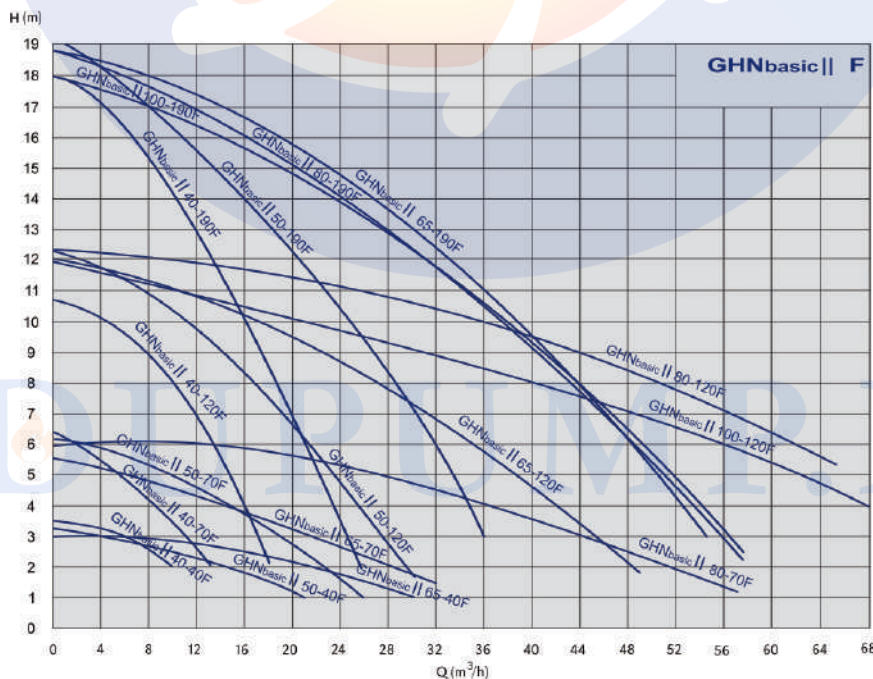

## Technical data & performance curves - GHNbasic II pumps

| Code      | Type                      | Q  | H    | PN (bar)   | Net weight (kg) |
|-----------|---------------------------|----|------|------------|-----------------|
| 979524575 | GHNbasic II 40-190F       | 27 | 18   | PN 6/10bar | 22              |
| 979524461 | GHNbasic II 40-120F       | 20 | 12   | PN 6/10bar | 17,9            |
| 979524462 | GHNbasic II 40-70F        | 13 | 6    | PN 6/10bar | 17,7            |
| 979524463 | GHNbasic II 40-40F        | 10 | 3,5  | PN 6/10bar | 17,4            |
| 979524576 | GHNbasic II 50-190F       | 37 | 19,5 | PN 6/10bar | 23,3            |
| 979524464 | GHNbasic II 50-120F       | 30 | 12   | PN 6/10bar | 24,6            |
| 979524465 | GHNbasic II 50-70F        | 25 | 6    | PN 6/10bar | 24,3            |
| 979524466 | GHNbasic II 50-40F        | 20 | 3,5  | PN 6/10bar | 24              |
| 979524577 | GHNbasic II 65-190F       | 57 | 18,5 | PN 6/10bar | 31,4            |
| 979524467 | GHNbasic II 65-120F       | 50 | 12   | PN 6/10bar | 30,8            |
| 979524468 | GHNbasic II 65-70F        | 35 | 6    | PN 6/10bar | 28,6            |
| 979524469 | GHNbasic II 65-40F        | 33 | 3,5  | PN 6/10bar | 28,6            |
| 979524578 | GHNbasic II 80-190F PN6   | 57 | 18,5 | PN 6bar    | 37              |
| 979524580 | GHNbasic II 80-190F PN10  | 57 | 18,5 | PN 10bar   | 37              |
| 979524470 | GHNbasic II 80-120F PN6   | 70 | 12   | PN 6bar    | 34,2            |
| 979524472 | GHNbasic II 80-120F PN10  | 70 | 12   | PN 10bar   | 34,4            |
| 979524471 | GHNbasic II 80-70F PN6    | 60 | 6    | PN 6bar    | 33,4            |
| 979524473 | GHNbasic II 80-70F PN10   | 60 | 6    | PN 10bar   | 32,8            |
| 979524579 | GHNbasic II 100-190F PN6  | 57 | 18,5 | PN 6bar    | 37              |
| 979524581 | GHNbasic II 100-190F PN10 | 57 | 18,5 | PN 10bar   | 37              |
| 979524474 | GHNbasic II 100-120F PN6  | 75 | 11,5 | PN 6bar    | 38,3            |
| 979524475 | GHNbasic II 100-120F PN10 | 75 | 11,5 | PN 10bar   | 37,5            |

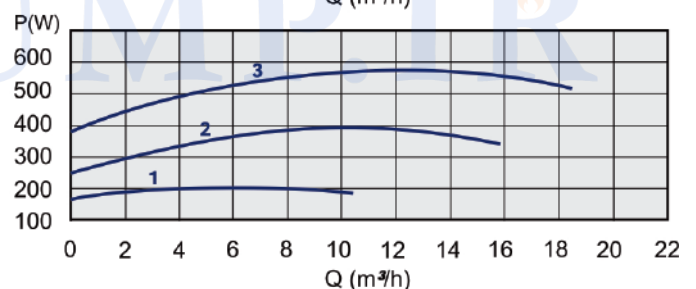
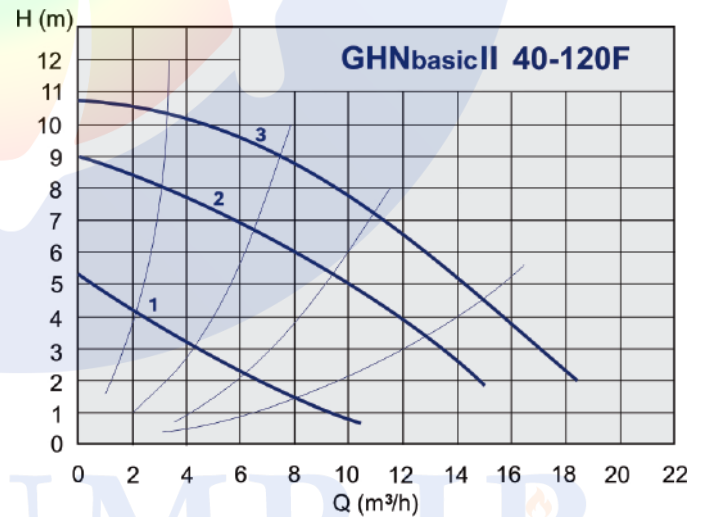
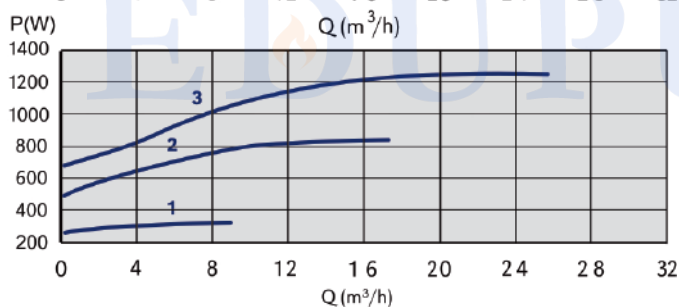
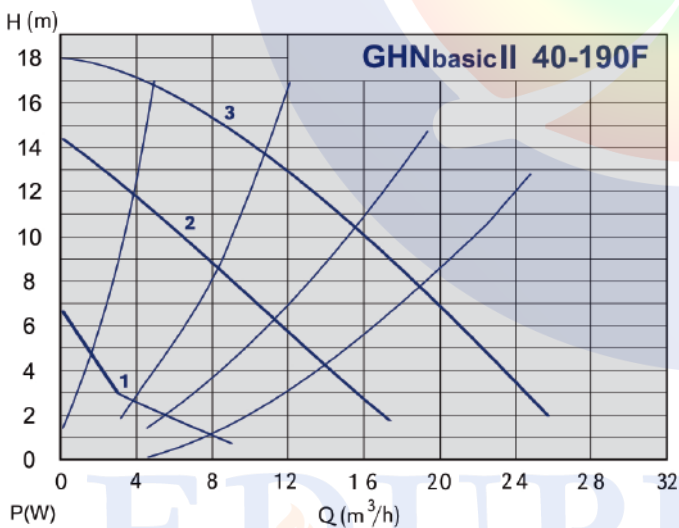

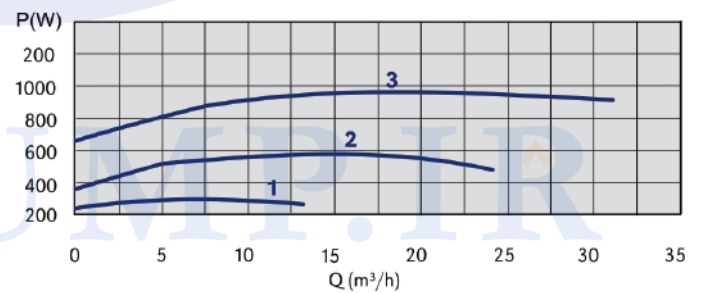
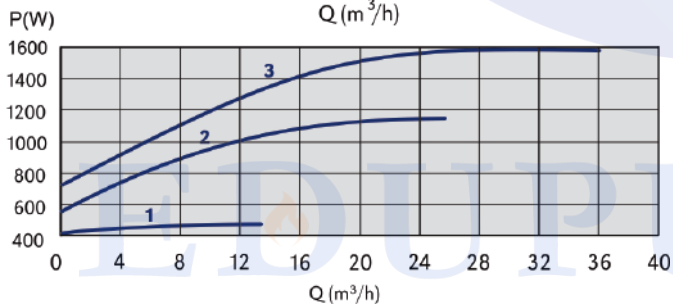
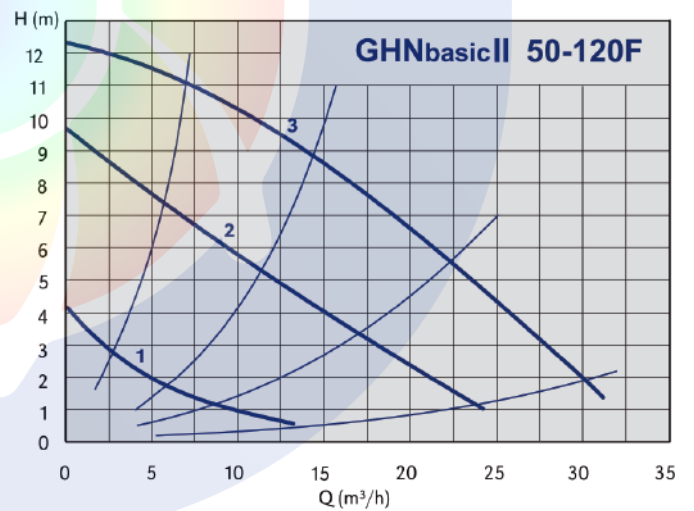
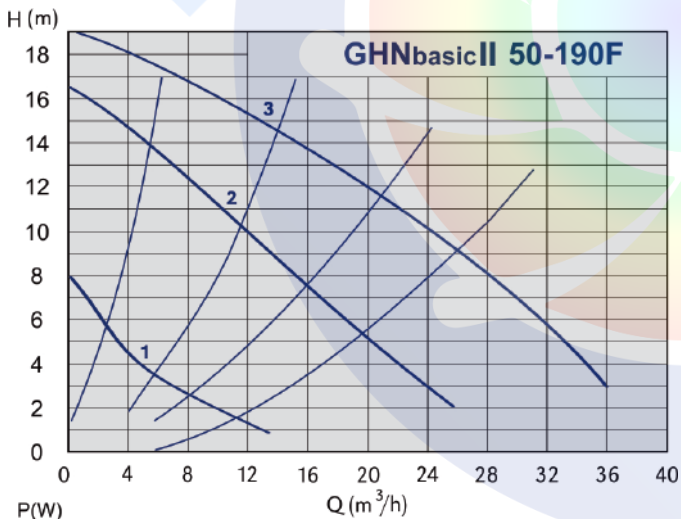
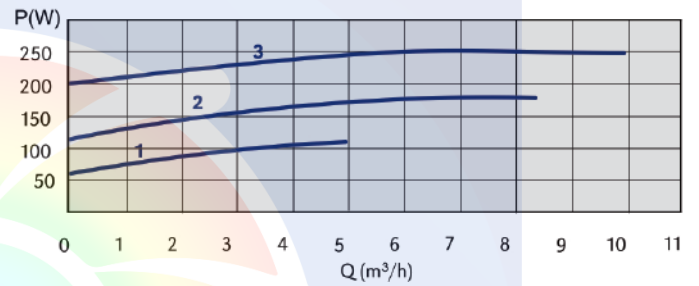
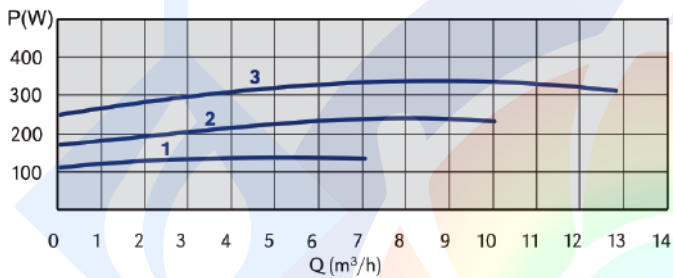
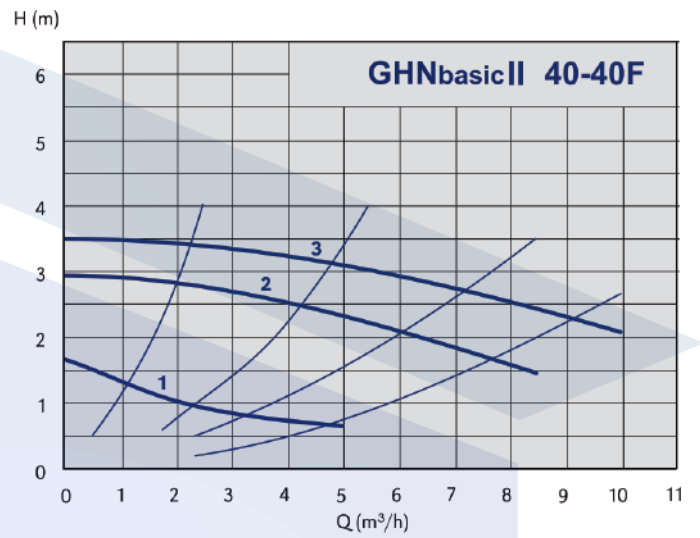
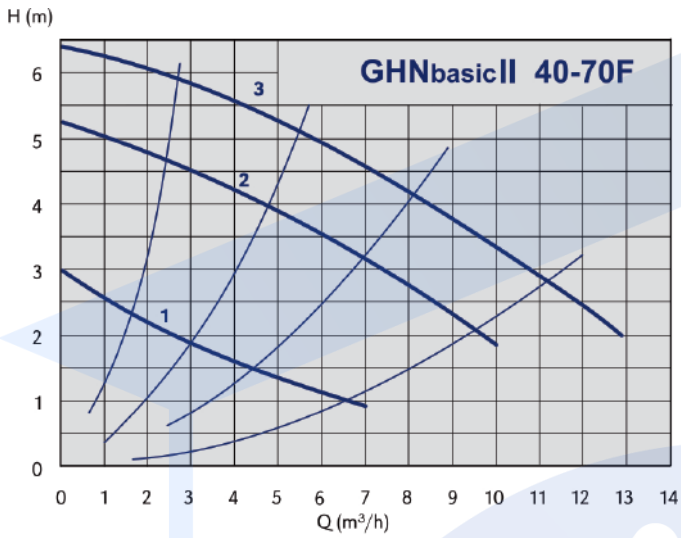

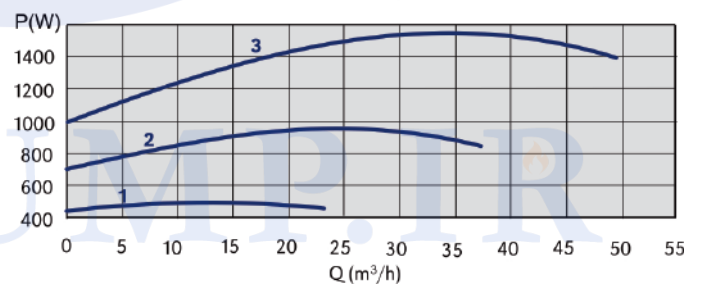
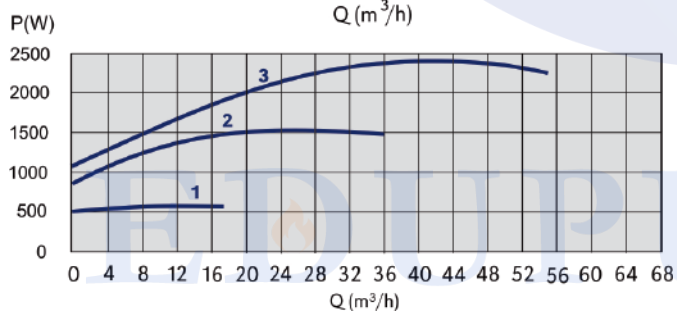
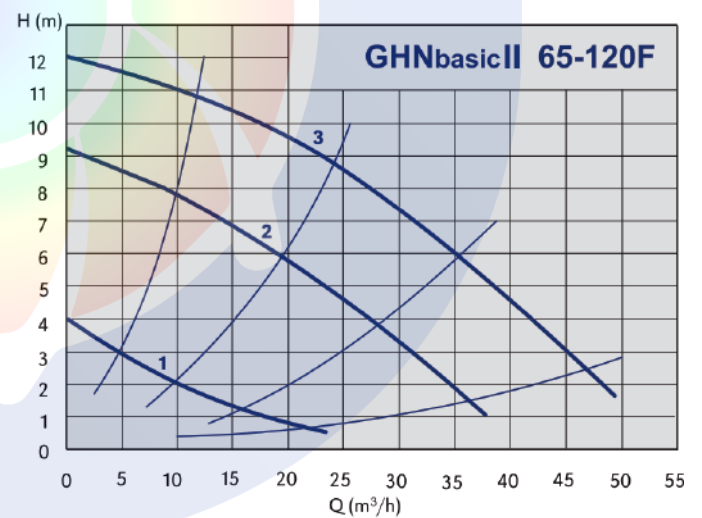
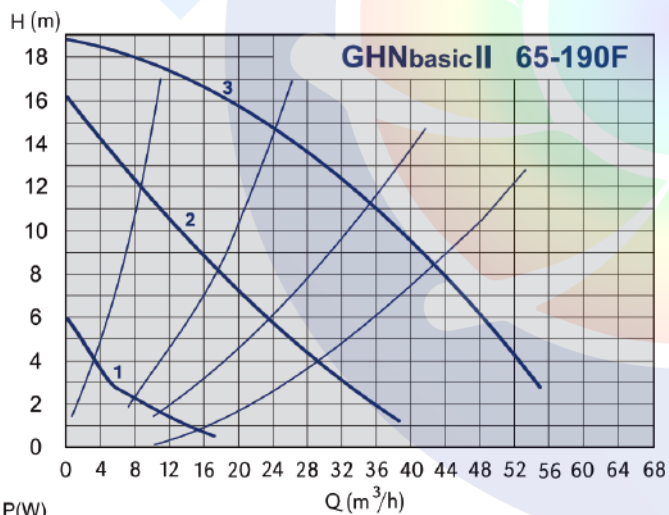
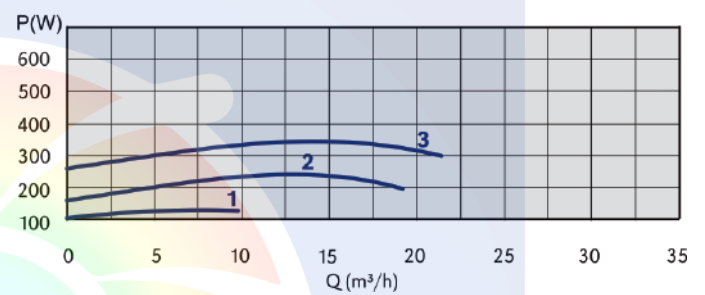
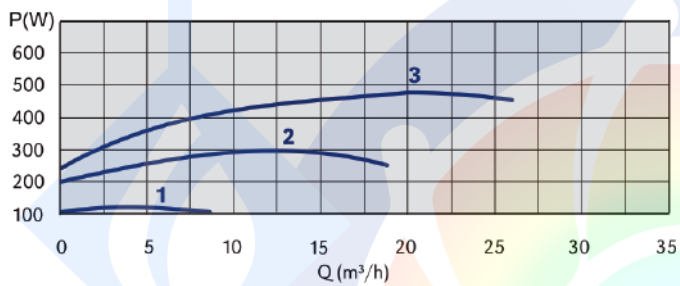
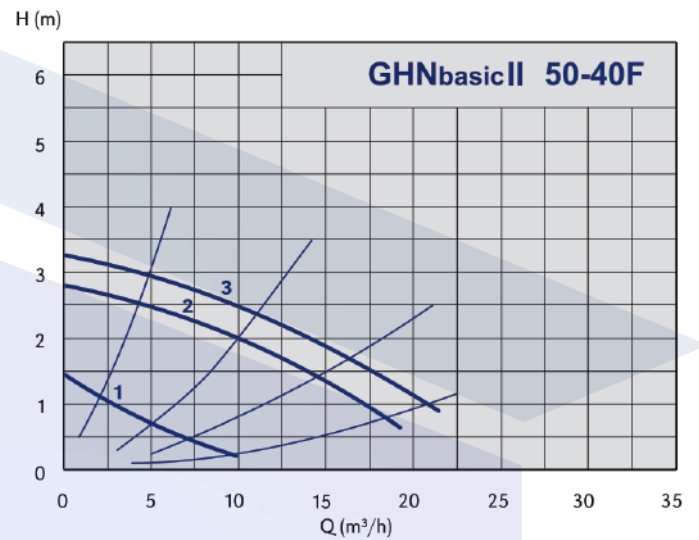
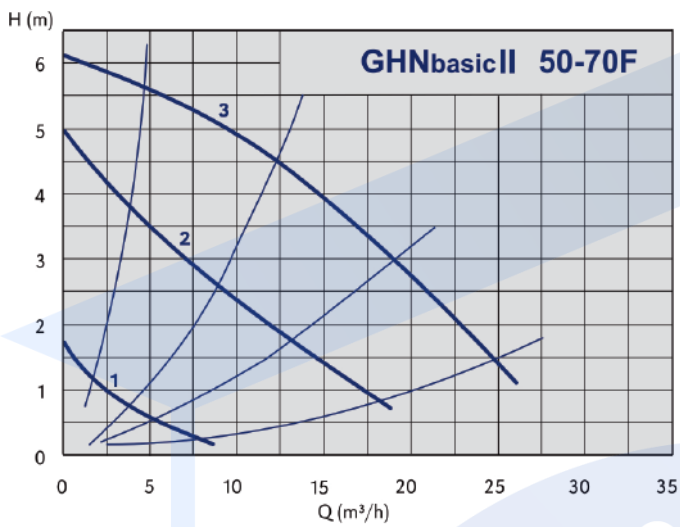

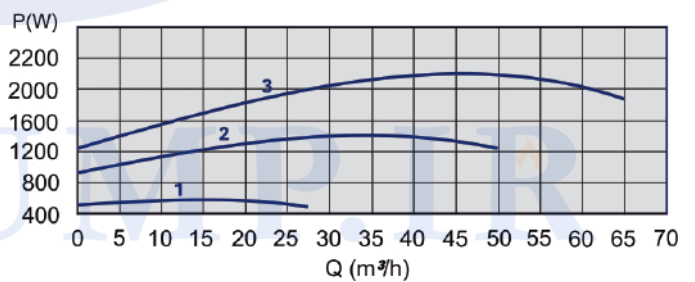
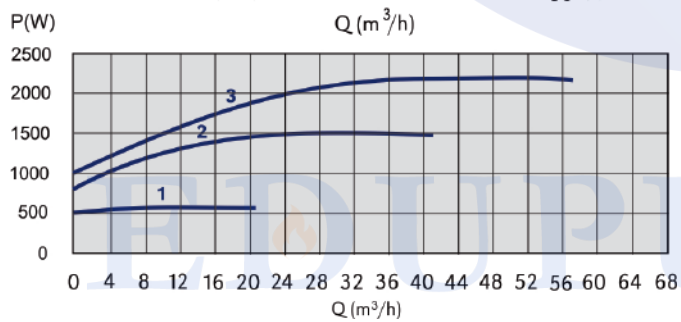
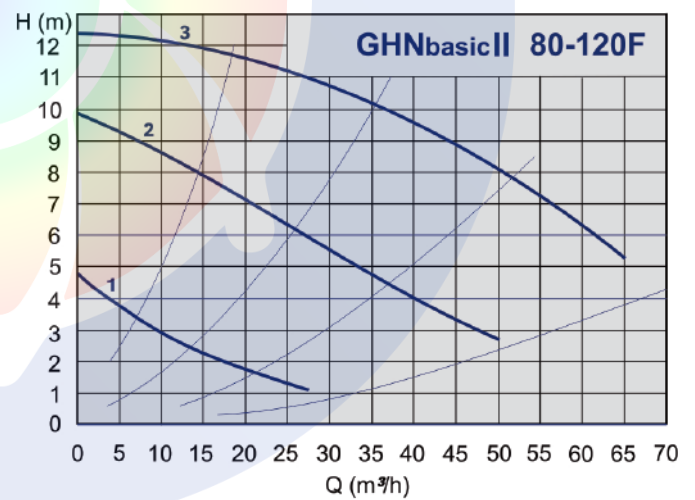
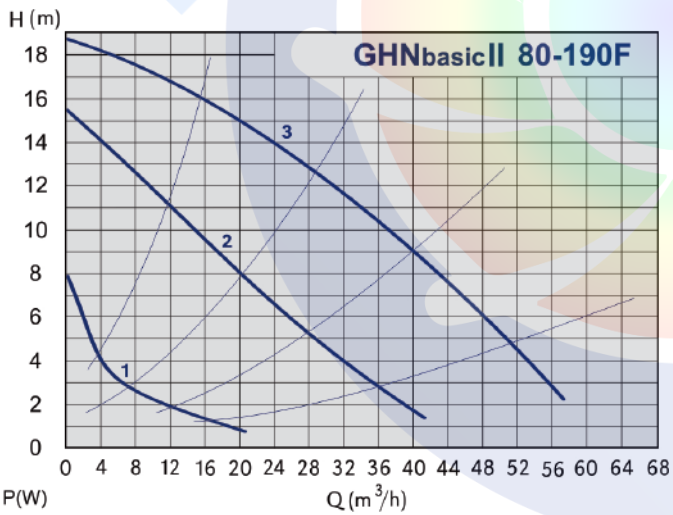
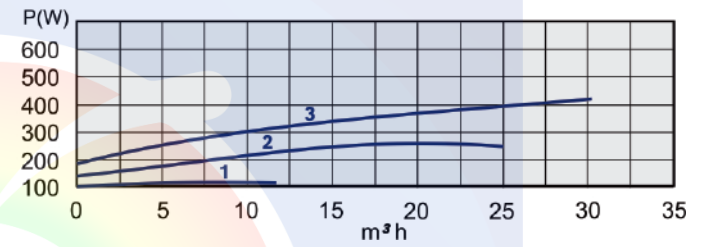
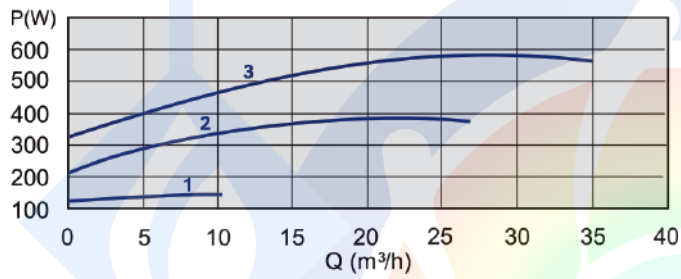
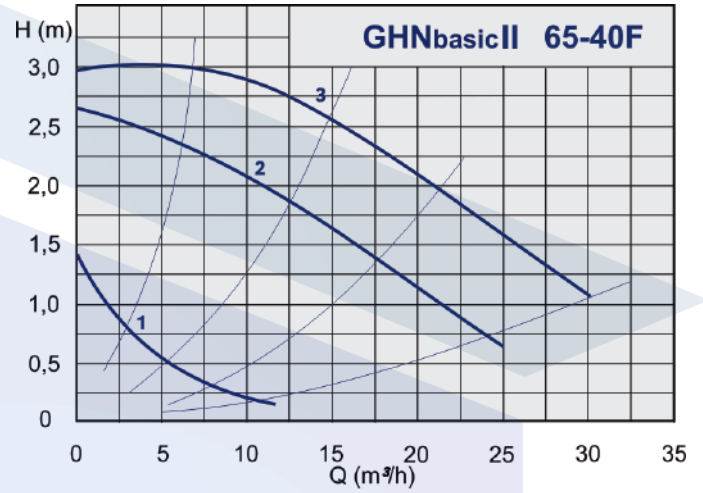
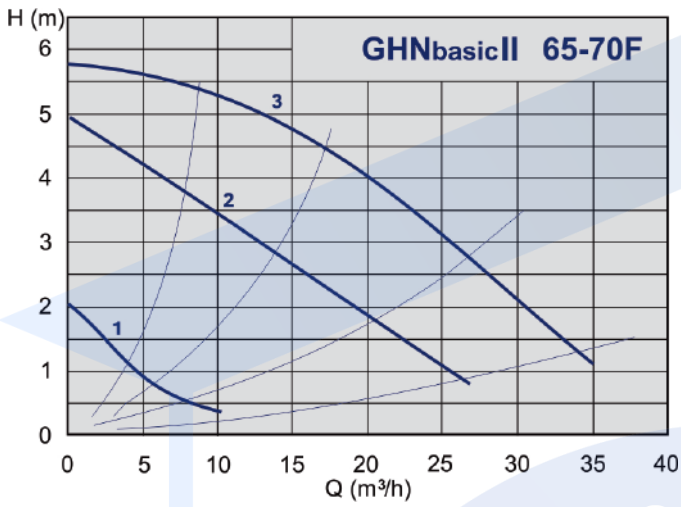

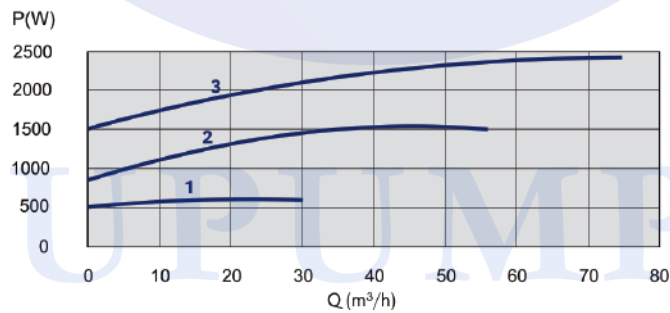
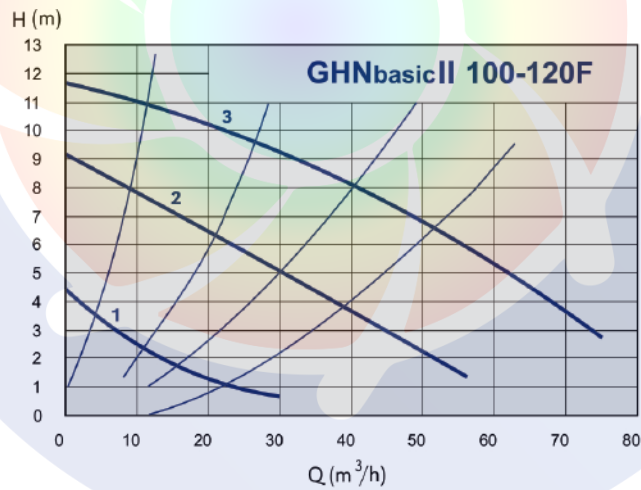
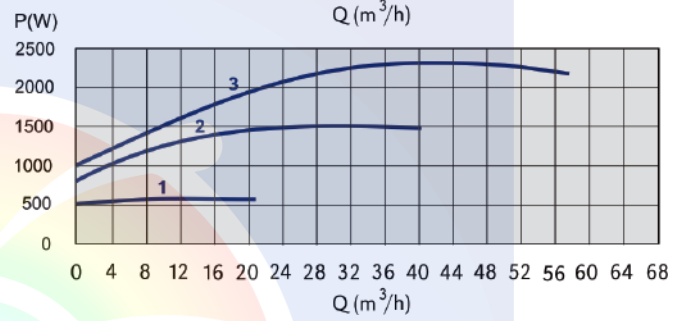
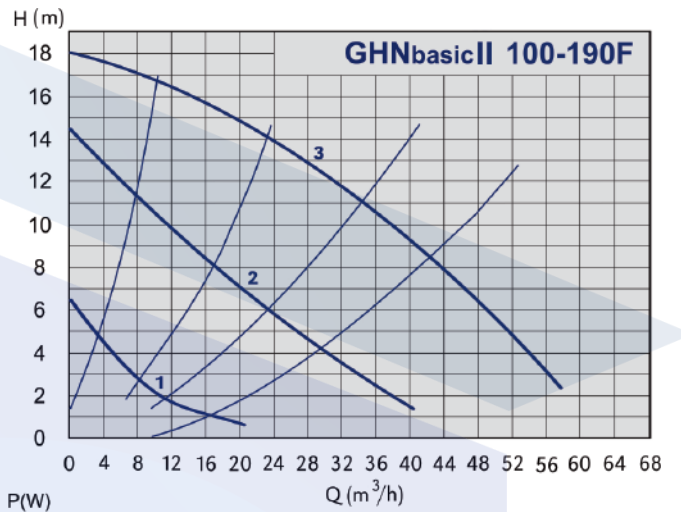
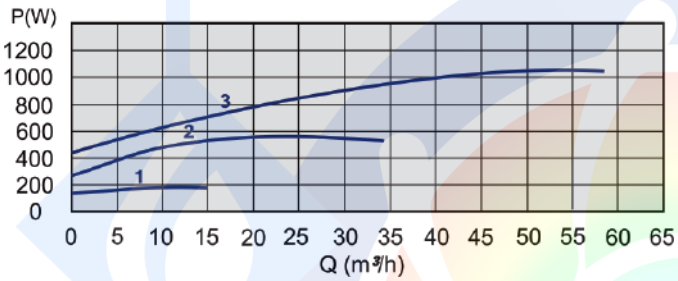
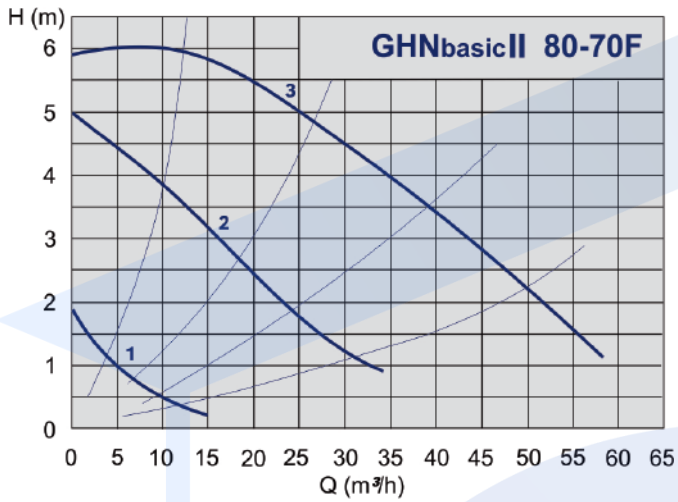

## Dimensions - GHNbasic II pumps

| Code      | Type                      | Fitting length (mm) | Connection size DN | a   | l   | b1  | b2    |
|-----------|---------------------------|---------------------|--------------------|-----|-----|-----|-------|
| 979524575 | GHNbasic II 40-190F       | 250                 | 40                 | 65  | 240 | 130 | 92,0  |
| 979524461 | GHNbasic II 40-120F       | 250                 | 40                 | 65  | 198 | 125 | 92,0  |
| 979524462 | GHNbasic II 40-70F        | 250                 | 40                 | 65  | 198 | 125 | 92,0  |
| 979524463 | GHNbasic II 40-40F        | 250                 | 40                 | 65  | 198 | 125 | 92,0  |
| 979524576 | GHNbasic II 50-190F       | 280                 | 50                 | 70  | 250 | 130 | 113,0 |
| 979524464 | GHNbasic II 50-120F       | 280                 | 50                 | 70  | 250 | 130 | 113,0 |
| 979524465 | GHNbasic II 50-70F        | 280                 | 50                 | 70  | 250 | 130 | 113,0 |
| 979524466 | GHNbasic II 50-40F        | 280                 | 50                 | 70  | 250 | 130 | 113,0 |
| 979524577 | GHNbasic II 65-190F       | 340                 | 65                 | 80  | 252 | 130 | 123,0 |
| 979524467 | GHNbasic II 65-120F       | 340                 | 65                 | 80  | 252 | 130 | 123,0 |
| 979524468 | GHNbasic II 65-70F        | 340                 | 65                 | 80  | 252 | 130 | 123,0 |
| 979524469 | GHNbasic II 65-40F        | 340                 | 65                 | 80  | 252 | 130 | 123,0 |
| 979524578 | GHNbasic II 80-190F PN6   | 360                 | 80                 | 100 | 257 | 130 | 130,0 |
| 979524580 | GHNbasic II 80-190F PN10  | 360                 | 80                 | 100 | 257 | 130 | 130,0 |
| 979524470 | GHNbasic II 80-120F PN6   | 360                 | 80                 | 100 | 257 | 130 | 129,5 |
| 979524472 | GHNbasic II 80-120F PN10  | 360                 | 80                 | 100 | 257 | 130 | 129,5 |
| 979524471 | GHNbasic II 80-70F PN6    | 360                 | 80                 | 100 | 257 | 130 | 129,5 |
| 979524473 | GHNbasic II 80-70F PN10   | 360                 | 80                 | 100 | 257 | 130 | 129,5 |
| 979524579 | GHNbasic II 100-190F PN6  | 360                 | 100                | 110 | 257 | 130 | 130,0 |
| 979524581 | GHNbasic II 100-190F PN10 | 360                 | 100                | 110 | 257 | 130 | 130,0 |
| 979524474 | GHNbasic II 100-120F PN6  | 360                 | 100                | 110 | 257 | 130 | 130,0 |
| 979524475 | GHNbasic II 100-120F PN10 | 360                 | 100                | 110 | 257 | 130 | 130,0 |

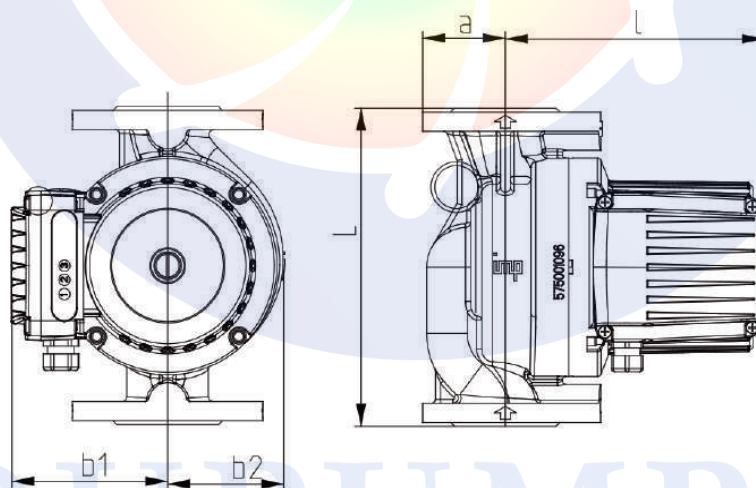



## Electrical & pressure data - GHNbasic II pumps

| Code      | Type                      | Pmax (W) | Speed range (min-1) | FLC I In (A) | insulating class | min. working pressure 50°C | min. working pressure 80°C | min. working pressure 110°C |
|-----------|---------------------------|----------|---------------------|--------------|------------------|----------------------------|----------------------------|-----------------------------|
| 979524575 | GHNbasic II 40-190F       | 1260     |                     | 0,61 - 2,24  | 200              | 0,05                       | 0,8                        | 1,4                         |
| 979524461 | GHNbasic II 40-120F       | 573      | 1250 - 2820         | 0,38 - 1,46  | 200              | 0,05                       | 0,8                        | 1,4                         |
| 979524462 | GHNbasic II 40-70F        | 317      | 1440 - 2790         | 0,23 - 0,74  | 200              | 0,05                       | 0,8                        | 1,4                         |
| 979524463 | GHNbasic II 40-40F        | 209      | 660 - 1440          | 0,12 - 0,70  | 200              | 0,05                       | 0,8                        | 1,4                         |
| 979524576 | GHNbasic II 50-190F       | 1596     |                     | 0,89 - 2,90  | 200              | 0,3                        | 1                          | 1,6                         |
| 979524464 | GHNbasic II 50-120F       | 1058     | 1270 - 2800         | 0,59 - 2,02  | 200              | 0,3                        | 1                          | 1,6                         |
| 979524465 | GHNbasic II 50-70F        | 465      | 560 - 1400          | 0,22 - 1,13  | 200              | 0,3                        | 1                          | 1,6                         |
| 979524466 | GHNbasic II 50-40F        | 282      | 620 - 1450          | 0,21 - 0,97  | 200              | 0,3                        | 1                          | 1,6                         |
| 979524577 | GHNbasic II 65-190F       | 2346     |                     | 1,05 - 4,00  | 200              | 0,3                        | 1                          | 1,6                         |
| 979524467 | GHNbasic II 65-120F       | 1522     | 1250 - 2810         | 0,89 - 2,83  | 200              | 0,3                        | 1                          | 1,6                         |
| 979524468 | GHNbasic II 65-70F        | 578      | 450 - 1370          | 0,31 - 1,50  | 200              | 0,3                        | 1                          | 1,6                         |
| 979524469 | GHNbasic II 65-40F        | 365      | 600 - 1430          | 0,21 - 1,05  | 200              | 0,3                        | 1                          | 1,6                         |
| 979524578 | GHNbasic II 80-190F PN6   | 2272     |                     | 1,08 - 3,90  | 200              | 0,3                        | 1                          | 1,6                         |
| 979524580 | GHNbasic II 80-190F PN10  | 2272     |                     | 1,08 - 3,90  | 200              | 0,3                        | 1                          | 1,6                         |
| 979524470 | GHNbasic II 80-120F PN6   | 2263     | 1200 - 2800         | 1,16 - 3,90  | 200              | 0,3                        | 1                          | 1,6                         |
| 979524472 | GHNbasic II 80-120F PN10  | 2263     | 1200 - 2800         | 1,16 - 3,90  | 200              | 0,3                        | 1                          | 1,6                         |
| 979524471 | GHNbasic II 80-70F PN6    | 1002     | 600 - 1350          | 0,43 - 2,20  | 200              | 0,3                        | 1                          | 1,6                         |
| 979524473 | GHNbasic II 80-70F PN10   | 1002     | 600 - 1350          | 0,43 - 2,20  | 200              | 0,3                        | 1                          | 1,6                         |
| 979524579 | GHNbasic II 100-190F PN6  | 2287     |                     | 1,07 - 3,90  | 200              | 0,3                        | 1                          | 1,6                         |
| 979524581 | GHNbasic II 100-190F PN10 | 2287     |                     | 1,07 - 3,90  | 200              | 0,3                        | 1                          | 1,6                         |
| 979524474 | GHNbasic II 100-120F PN6  | 2324     | 1200 - 2800         | 1,16 - 4,00  | 200              | 0,3                        | 1                          | 1,6                         |
| 979524475 | GHNbasic II 100-120F PN10 | 2324     | 1200 - 2800         | 1,16 - 4,00  | 200              | 0,3                        | 1                          | 1,6                         |

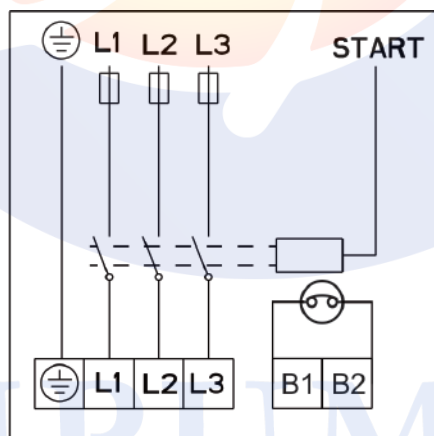



**EDUPUMP**  
WWW.EDUPUMP.IR

## اولین و بزرگترین

سایت تخصصی سیستم‌های پمپاژ  
با امکان محاسبه آنلاین و انتخاب پمپ

## تولید بوستر پمپ آتش نشانی

در کلاس‌های S3 - S2 - S1  
مورد تایید سازمان آتش نشانی تهران



اولین و بزرگترین مرجع انتخاب آنلاین سیستم‌های پمپاژ

انتخاب آنلاین انواع بوستر پمپ

انتخاب آنلاین انواع پمپ

ارائه مطالب تخصصی

## اولین سایت مرجع

## انتخاب آنلاین پمپ

در حوزه‌های:

ایمنی و آتش نشانی  
آب و فاضلاب  
صنایع غذایی  
استخر  
صنعت  
معدن

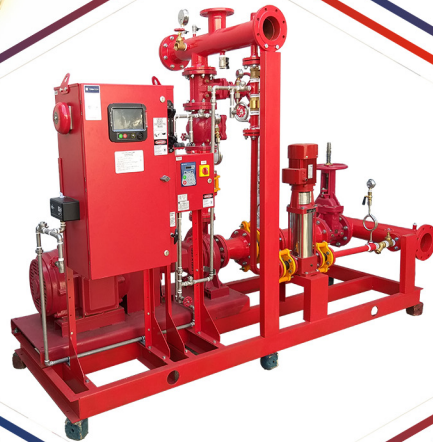

## تولید بوستر پمپ

## آبرسانی دور متغیر

بدون محدودیت برند



## آموزش

تهویه و تخلیه دود  
سیستم‌های پمپاژ  
ایمنی معماری  
اطفاء حریق  
اعلام حریق

## مشاوره - طراحی - اجراء

تاسیسات مکانیکی (موتورخانه - استخر)  
تهویه و تخلیه دود  
سیستم‌های پمپاژ  
ایمنی معماری  
اعلام حریق  
اطفاء حریق

تهران، سعدی شمالی، خیابان مرادی نور، پلاک ۳۱

تلفن: ۰۲۱-۷۷۶۸۶۹۶۶ فکس: ۰۲۱-۷۷۶۷۸۶۵۹

EDUPUMP.IR

WWW.EDUPUMP.IR