



IN-LINE PUMPS

TECHNICAL DATA

(E)CL(D) - in-line pumps

(E)CL(D) 50 - 290 / 2 / 3.0 A / L - H - DTT

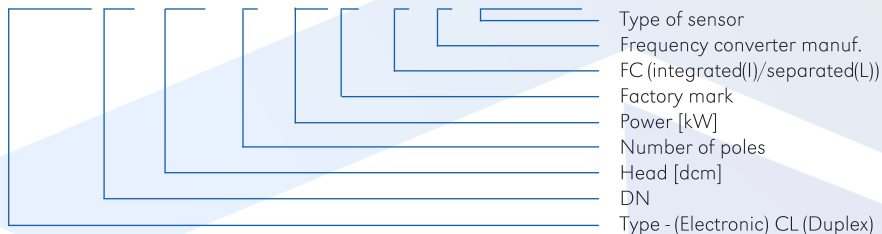

Construction

Close-coupled, single-impeller, centrifugal pumps with standard electric motor and electric motor with extended shaft. Pump casing with suction and delivery connections with the same diameter and on the same axis (in-line).

Motor

2 poles $n \approx 2900$ rpm; 50Hz
 4 poles $n \approx 1450$ rpm; 50Hz

Three phase (depending on motor power);
 230V/400V
 400V/690V

Technical specification of the motor	
Rated power	0,25kW - 37,0kW
Efficiency class	IE 3 $\geq 0,75$ kW > IE2
Degree of protection	IP 55
Insulation class	F
MEI	MEI $\geq 0,40$
ErP	EuP Standalone product
ATEX	in accordance

Technical data

TECHNICAL FEATURES	CL/ECL	CLD/ECLD
CONNECTIONS (DN)	40 TO 150	40 TO 100
CONNECTION TYPE	FLANGE	FLANGE
MAX OPERATING PRESSURE (PN)	10/16	10/16
AMBIENT TEMPERATURE	-30°C TO +60°C	-30°C TO +60°C
MEDIA TEMPERATURE	-25°C TO +130°C/+140°C	-25°C TO +130°C/+140°C
TWIN PUMP	NO	YES
APPLICATIONS	CL/ECL	CLD/ECLD
HEATING	YES	YES
COOLING	YES	YES
SANITARY WATER	NO	NO
CLIMATE APPLIANCES	YES	YES
INDUSTRY	YES	YES
PROCESS TECHNIQUE	YES	YES
CONDENSATION	YES	YES
SALT WATER	NO	NO
MATERIALS	CL/ECL	CLD/ECLD
HYDRAULIC CASING	CAST IRON	CAST IRON
IMPELLER	CAST IRON	CAST IRON
SHAFT	STAINLESS STEEL	STAINLESS STEEL
MECHANICAL SEAL STANDARD	BAQUE, 120°C	BAQUE, 120°C
MECHANICAL SEAL OPTIONAL	B, 140°C	B, 140°C

CL 2 poles DN50F

Code	Type	P [kW]	I [A]	H [m]	Q [m³/h]													
					12	13,5	15	18	21	24	27	30	36	42	48	54	60	75
979522031	CL 50-160/2/1.1	1,1	2,32				12	11	10									
979523794	CL 50-170/2/1.5A	1,5	3,4				15,5	15	14,1	13	11,8	10,5	7					
979522030	CL 50-190/2/1.5	1,5	3,07				16,5	15,5	15	13,5								
979523795	CL 50-200/2/2.2A	2,2	4,6				19	18,5	17,5	16,5	15,5	14	10,5					
979522032	CL 50-240/2/2.2	2,2	4,43				21	20	19,5	17,8	16							
979525071	CL 50-250/2/3.0A	3	5,6				24,5	24	23,5	23	22	20,5	17					
979522033	CL 50-290/2/3.0	3	5,77				27,3	26,2	25,5	24,5	23	22						
979523796	CL 50-310/2/3.0A	3	5,6				29,5	28,5	27,5	26	25	23	18					
979522034	CL 50-360/2/4.0	4	7,5				34	33	32,4	32	30,5	29,5						
979523797	CL 50-370/2/4.0A	4	8,2				35,5	34,5	34	32,5	31,5	30	26					
979522036	CL 50-420/2/7.5	7,5	14,1				45	44,8	44	43,7	43	42,5	41	28	35	32		
979522035	CL 50-430/2/5.5	5,5	10,6				41	40,2	40	39	37	36	35,5	33				
979522037	CL 50-540/2/11.0	11	20,1				55,3	55	54,9	54,8	54	53,5	52	49,5	46	43		
979520870	CL 50-550/2/11.0	11	20,4				55	54,5	54	53,5	52	51	46	44,5	36			
979522038	CL 50-630/2/15.0	15	27,1				65	65	64,5	64	63,5	63	62	59	56	53		
979525073	CL 50-700/2/11.0A	11	19,9				69	67,5	67	65	62,5	60,5	55					
979525074	CL 50-780/2/15.0A	15	26,8				77	76	74,5	74	71	69,5	64,5	60				
979525075	CL 50-910/2/15.0A	15	26,8				89,5	89	88,5	87	85	83,5	78	71				

CL 2 poles DN65F

Code	Type	P [kW]	I [A]	H [m]	Q [m³/h]														
					18	21	24	27	30	36	42	48	54	60	75	90	105	120	
979522081	CL 65-170/2/2.2	2,2	4,43					15,9	15,5	15,2	13,8	12,7	11						
979522082	CL 65-210/2/3.0	3	5,77					19,5	19,3	18,9	18,5	17	15,5	13,7					
979520875	CL 65-250/2/5.5	5,5	10,6					23	22,5	22	21,5	20,5	19	18	17,5				
979522083	CL 65-260/2/4.0A	4	7,5					25,5	25,3	25	24	23	21,5	20	18				
979522084	CL 65-340/2/5.5	5,5	10,6					33	32,5	32	31	29,5	28,5	26,5					
979520874	CL 65-350/2/7.5	7,5	14,1					34	33,5	33	32	31	29	28	26,5				
979523001	CL 65-370/2/7.5A	7,5	14,4					37	36,5	36	35	34	32,5	31	29				
979522085	CL 65-410/2/7.5	7,5	14,1					40	39,9	39,5	39	38	36,5	34,5	32				
979523804	CL 65-520/2/11.0A	11	19,9					50,5	50	49,5	47	45	43	40	36				
979520873	CL 65-550/2/15.0	15	27,6					54	53,5	53	52	50	48	45	42,5	36			
979525078	CL 65-810/2/18.5A	18,5	33					80	79	78,5	77,5	75,5	72,3	70,5	67,5				
979525079	CL 65-910/2/22.0A	22	39,4					90,5	90	89,5	88,5	86,5	83	81					

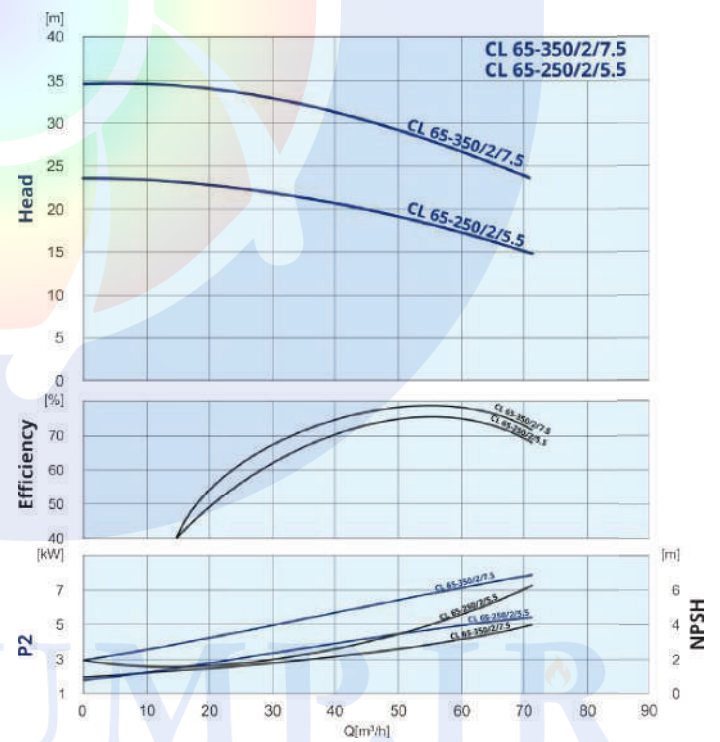
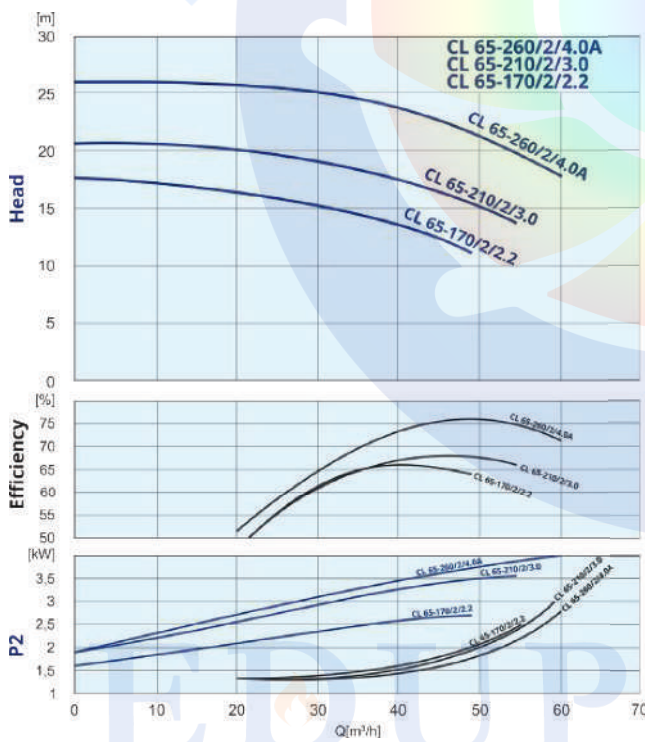
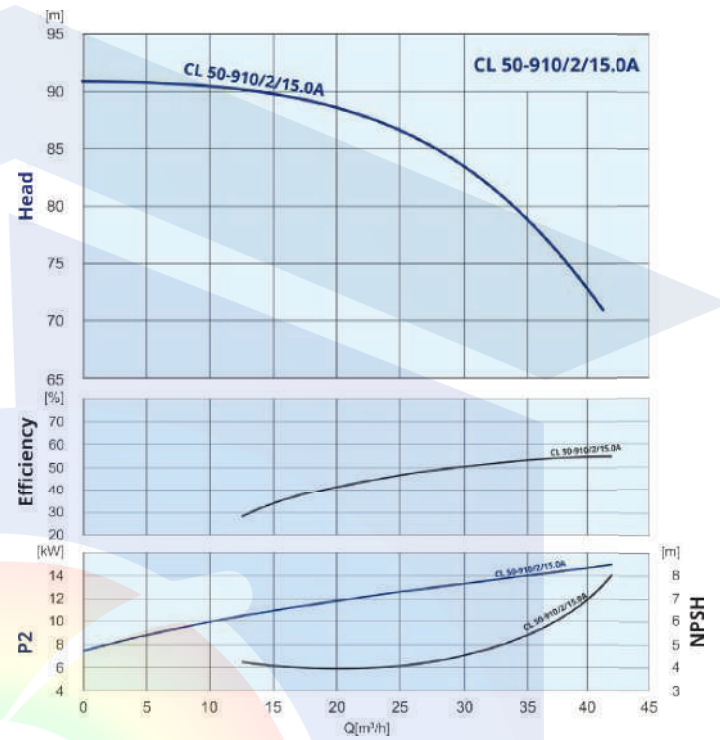
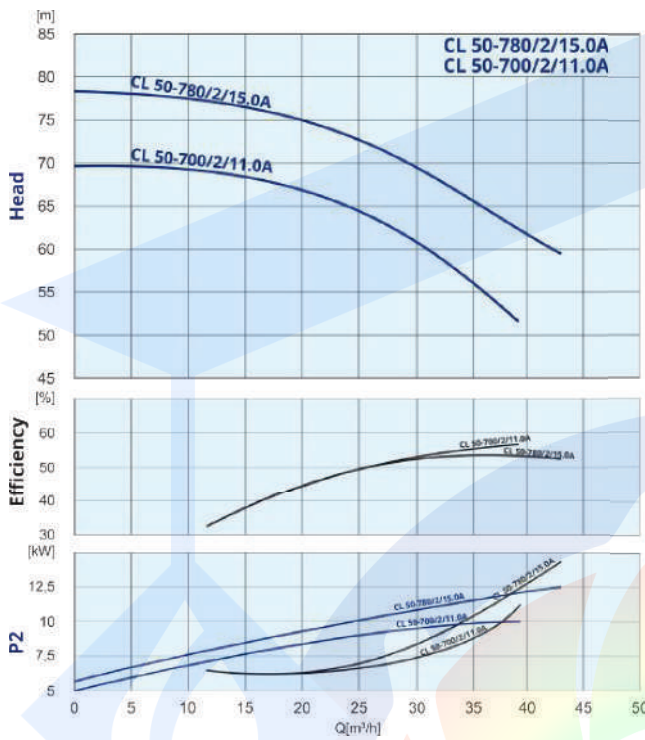

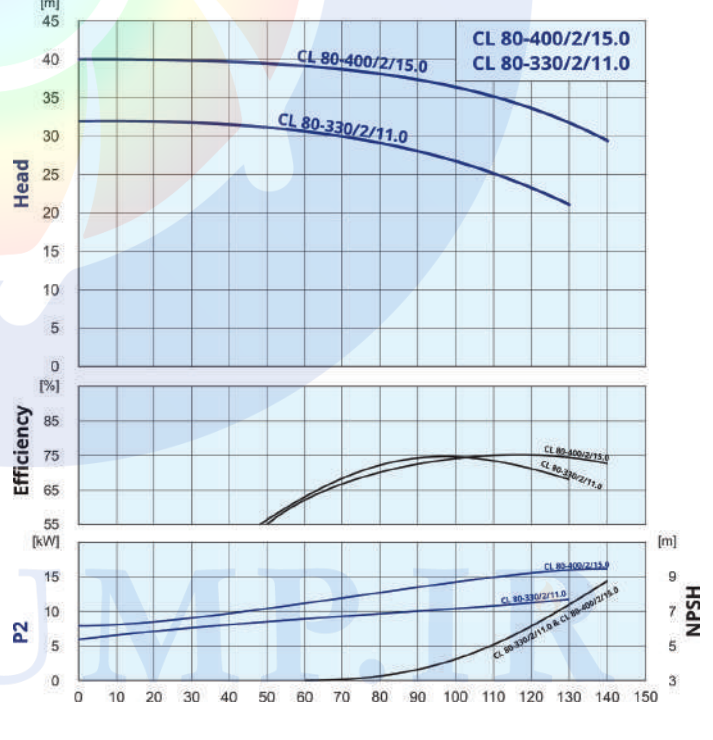
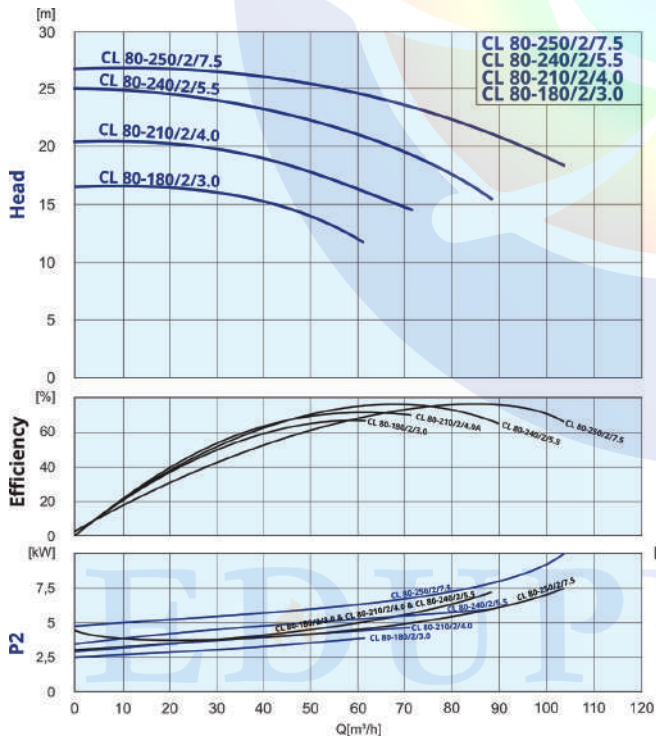
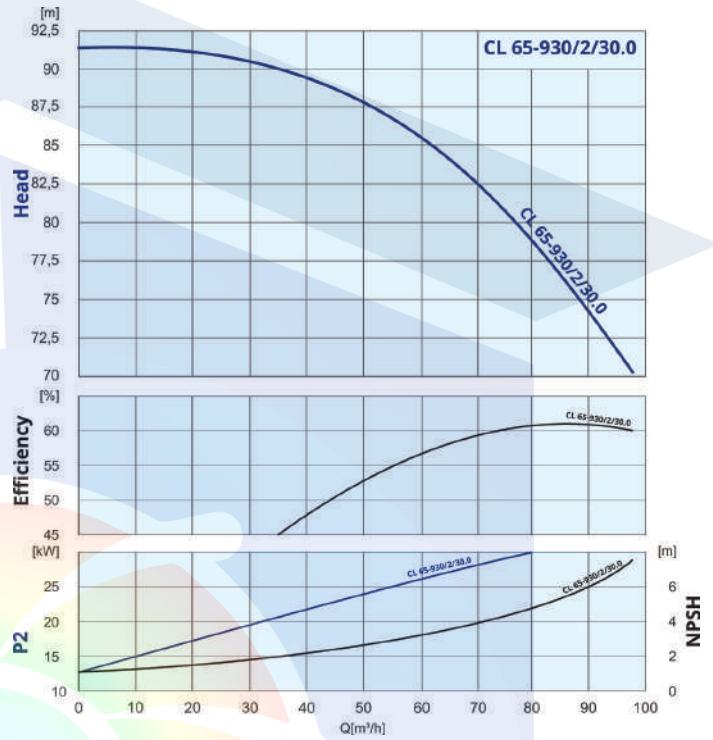
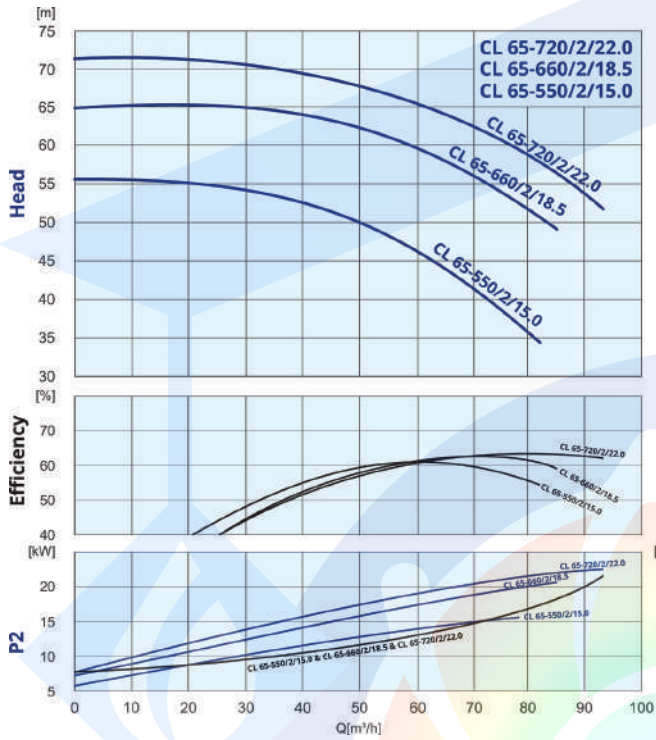

CL 2 poles - Dimensions

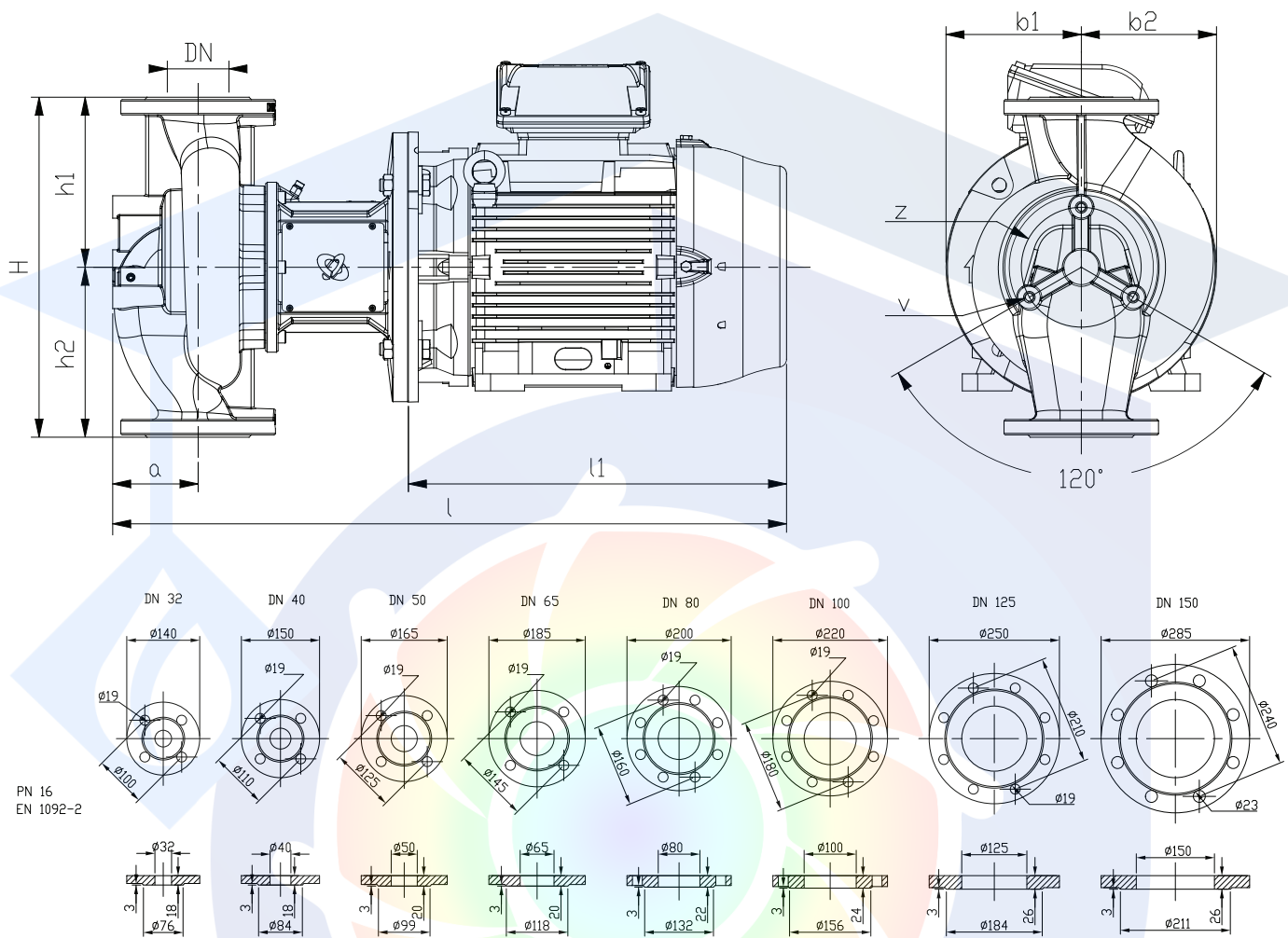

CL 2 poles DN40F

Code	Type	H	h1	h2	DN	a	l	l1	b1	b2	z	v	PN	Kg
979525070	CL 40-170/2/0.75A	300	140	160	40	100	446	/	93	129	/	/	10	26
979523782	CL 40-220/2/1.1A	300	140	160	40	100	446	/	93	129	/	/	10	27
979523783	CL 40-250/2/1.5A	300	140	160	40	100	446	/	93	129	/	/	10	29
979523784	CL 40-290/2/2.2A	320	150	170	40	100	481	/	108	138	/	/	10	31
979520868	CL 40-350/2/4.0	360	180	180	40	90	559	314	133	127	/	/	16	70
979523786	CL 40-380/2/3.0A	320	150	170	40	100	520	/	108	145	/	/	10	42
979522078	CL 40-430/2/5.5	440	220	220	40	106	700	371	164	164	142	M12x35	16	113
979523787	CL 40-470/2/4.0A	380	180	200	40	100	520	/	127	145	/	/	10	50
979522079	CL 40-530/2/7.5	440	220	220	40	106	700	371	164	164	142	M12x35	16	122
979523789	CL 40-550/2/5.5A	380	180	200	40	100	542	/	127	160	/	/	10	57
979520867	CL 40-600/2/5.5	390	190	200	40	90	639	361	145	135	/	/	16	76
979523790	CL 40-625/2/7.5A	380	180	200	40	100	564	/	127	160	/	/	10	60
979522080	CL 40-630/2/11.0	440	220	220	40	106	848,5	489,5	177	177	142	M12x35	16	177
979523791	CL 40-680/2/7.5A	440	210	230	40	100	584	/	165	160	/	/	10	57
979523792	CL 40-830/2/11.0A	440	210	230	40	100	659	/	165	194	/	/	10	80
979523793	CL 40-920/2/15.0A	440	210	230	40	100	710	/	165	194	/	/	10	84

CL 2 poles DN50F

Code	Type	H	h1	h2	DN	a	l	l1	b1	b2	z	v	PN	Kg
979522031	CL 50-160/2/1.1	340	170	170	50	114	502	237	120	116	130	M12x35	16	44
979523794	CL 50-170/2/1.5A	322	140	182	50	110	456	/	103	129	/	/	10	30
979522030	CL 50-190/2/1.5	340	170	170	50	114	520	255	120	116	130	M12x35	16	48
979523795	CL 50-200/2/2.2A	322	140	182	50	110	491	/	103	128	/	/	10	29
979522032	CL 50-240/2/2.2	340	170	170	50	114	545	280	120	116	130	M12x35	16	53,5
979525071	CL 50-250/2/3.0A	322	140	182	50	110	530	/	103	145	/	/	10	37
979522033	CL 50-290/2/3.0	340	170	170	50	114	609	316	141	141	130	M12x35	16	61,5
979523796	CL 50-310/2/3.0A	340	160	180	50	110	530	/	113	145	/	/	10	37
979522034	CL 50-360/2/4.0	340	170	170	50	100	624	334	168	168	130	M12x35	16	71
979523797	CL 50-370/2/4.0A	340	160	180	50	110	530	/	113	145	/	/	10	42
979522036	CL 50-420/2/7.5	440	220	220	50	117,5	715	370,5	163	163	142	M12x35	16	180
979522035	CL 50-430/2/5.5	340	170	170	50	100	701	371	150	150	130	M12x35	16	100
979522037	CL 50-540/2/11.0	440	220	220	50	117,5	864	489,5	177	177	142	M12x35	16	176
979520870	CL 50-550/2/11.0	425	205	220	50	96	789	479	150	135	/	/	16	130
979522038	CL 50-630/2/15.0	440	220	220	50	117,5	864	489,5	177	177	142	M12x35	16	124
979525073	CL 50-700/2/11.0A	440	210	230	50	125	684	/	165	194	/	/	10	93
979525074	CL 50-780/2/15.0A	440	210	230	50	125	735	/	165	194	/	/	10	97
979525075	CL 50-910/2/15.0A	440	210	230	50	125	735	/	165	194	/	/	10	98

CL 2 poles DN65F

Code	Type	H	h1	h2	DN	a	l	l1	b1	b2	z	v	PN	Kg
979522081	CL 65-170/2/2.2	360	180	180	65	114	557	280	130	118	142	M12x35	16	59,5
979522082	CL 65-210/2/3.0	360	180	180	65	114	621	316	141	141	142	M12x35	16	70,5
979520875	CL 65-250/2/5.5	360	180	180	65	114	639	334	168	168	142	M12x35	16	76
979522083	CL 65-260/2/4.0A	360	155	205	65	140	560	/	108	145	/	/	10	78
979522084	CL 65-340/2/5.5	360	180	180	65	106,5	718	371	150	150	142	M12x35	16	102
979520874	CL 65-350/2/7.5	420	200	220	65	95	611	361	138	125	/	/	16	99
979523001	CL 65-370/2/7.5A	400	180	220	65	140	604	/	122	160	/	/	10	58
979522085	CL 65-410/2/7.5	360	180	180	65	106,5	718	371	150	150	142	M12x35	16	112
979523804	CL 65-520/2/11.0A	440	200	240	65	140	679	/	136	194	/	/	10	83
979520873	CL 65-550/2/15.0	480	225	255	65	95	835	521	160	140	/	/	16	157
979525078	CL 65-810/2/18.5A	475	225	250	65	140	847	/	165	238	/	/	10	140
979525079	CL 65-910/2/22.0A	475	225	250	65	140	847	/	165	238	/	/	10	152

EDUPUMP.IR



EDUPUMP
WWW.EDUPUMP.IR

اولین و بزرگترین

سایت تخصصی سیستم‌های پمپاژ
با امکان محاسبه آنلاین و انتخاب پمپ

تولید بوستر پمپ آتش نشانی

در کلاس‌های S3 - S2 - S1
مورد تایید سازمان آتش نشانی تهران



اولین و بزرگترین مرجع انتخاب آنلاین سیستم‌های پمپاژ

انتخاب آنلاین انواع بوستر پمپ

انتخاب آنلاین انواع پمپ

ارائه مطالب تخصصی

اولین سایت مرجع

انتخاب آنلاین پمپ

در حوزه‌های:

ایمنی و آتش نشانی
آب و فاضلاب
صنایع غذایی
استخر
صنعت
معدن

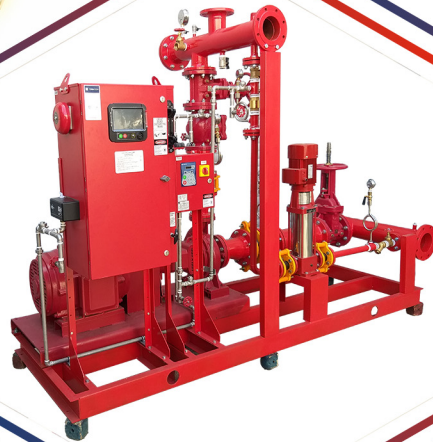

تولید بوستر پمپ

آبرسانی دور متغیر

بدون محدودیت برند



آموزش

تهویه و تخلیه دود
سیستم‌های پمپاژ
ایمنی معماری
اطفاء حریق
اعلام حریق

مشاوره - طراحی - اجراء

تاسیسات مکانیکی (موتورخانه - استخر)
تهویه و تخلیه دود
سیستم‌های پمپاژ
ایمنی معماری
اعلام حریق
اطفاء حریق

تهران، سعدی شمالی، خیابان مرادی نور، پلاک ۳۱

تلفن: ۰۲۱-۷۷۶۸۶۹۶۶ فکس: ۰۲۱-۷۷۶۷۸۶۵۹

EDUPUMP.IR

WWW.EDUPUMP.IR