



IN-LINE PUMPS

TECHNICAL DATA

(E)CL(D) - in-line pumps

(E)CL(D) 50 - 290 / 2 / 3.0 A / L - H - DTT

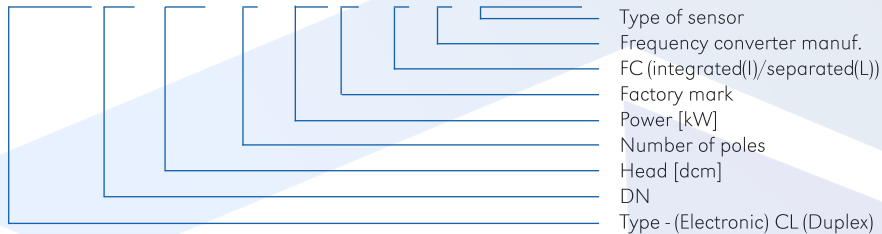

Construction

Close-coupled, single-impeller, centrifugal pumps with standard electric motor and electric motor with extended shaft. Pump casing with suction and delivery connections with the same diameter and on the same axis (in-line).

Motor

2 poles $n \approx 2900$ rpm; 50Hz
 4 poles $n \approx 1450$ rpm; 50Hz

Three phase (depending on motor power);
 230V/400V
 400V/690V

Technical specification of the motor	
Rated power	0,25kW - 37,0kW
Efficiency class	IE 3 $\geq 0,75$ kW > IE2
Degree of protection	IP 55
Insulation class	F
MEI	MEI $\geq 0,40$
ErP	EuP Standalone product
ATEX	in accordance

Technical data

TECHNICAL FEATURES	CL/ECL	CLD/ECLD
CONNECTIONS (DN)	40 TO 150	40 TO 100
CONNECTION TYPE	FLANGE	FLANGE
MAX OPERATING PRESSURE (PN)	10/16	10/16
AMBIENT TEMPERATURE	-30°C TO +60°C	-30°C TO +60°C
MEDIA TEMPERATURE	-25°C TO +130°C/+140°C	-25°C TO +130°C/+140°C
TWIN PUMP	NO	YES
APPLICATIONS	CL/ECL	CLD/ECLD
HEATING	YES	YES
COOLING	YES	YES
SANITARY WATER	NO	NO
CLIMATE APPLIANCES	YES	YES
INDUSTRY	YES	YES
PROCESS TECHNIQUE	YES	YES
CONDENSATION	YES	YES
SALT WATER	NO	NO
MATERIALS	CL/ECL	CLD/ECLD
HYDRAULIC CASING	CAST IRON	CAST IRON
IMPELLER	CAST IRON	CAST IRON
SHAFT	STAINLESS STEEL	STAINLESS STEEL
MECHANICAL SEAL STANDARD	BAQUE, 120°C	BAQUE, 120°C
MECHANICAL SEAL OPTIONAL	B, 140°C	B, 140°C

Performance range

(E)CL(D) 2 poles \approx 2900 rpm

(E)CL(D) 4 poles \approx 1450 rpm

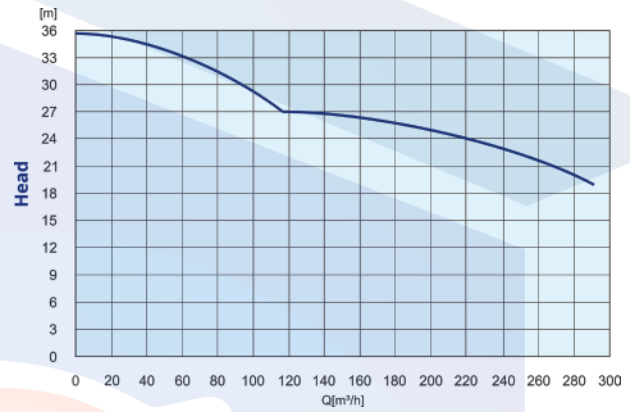
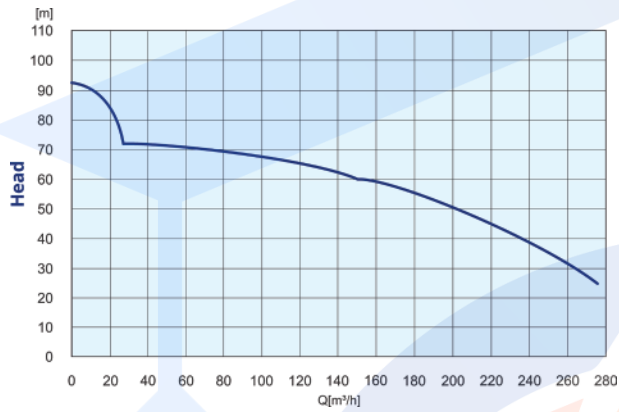

CL 2 poles - Q/H performance

CL 2 poles DN 40F

Code	Type	P [kW]	I [A]	H [m]	Q [m³/h]															
					6	7,5	9	10,5	12	13,5	15	18	21	24	27	30	36	42		
979525070	CL 40-170/2/0.75A	0,75	1,6	H [m]	15	14,5	13,5	13	11,8	10,5	9,5	6								
979523782	CL 40-220/2/1.1A	1,1	2,5		20,5	20	19	18	17	16	15	11,5	7,5							
979523783	CL 40-250/2/1.5A	1,5	3,4		24,5	24	23,5	23	22	21	20	16,5	13							
979523784	CL 40-290/2/2.2A	2,2	4,6		28,5	28	27,5	26,5	25,5	24	23	20	15							
979520868	CL 40-350/2/4.0	4	7,7		34	33	32	31,5	31	30	29	26,5	24	21	17,5	13,5				
979523786	CL 40-380/2/3.0A	3	5,6		36,5	36	35,5	35	34,5	33,5	32	30								
979522078	CL 40-430/2/5.5	5,5	10,6		44	43,5	43,5	43,3	43	42,5	42	41	39,5	38	37,5	35	30	24		
979523787	CL 40-470/2/4.0A	4	8,2		47	46,5	46	45	44	43	42	39,5	37,5	34						
979522079	CL 40-530/2/7.5	7,5	14,1		53	52,7	52,3	51,8	51,5	51	50,5	49	48	46,5	45	42,7	38,5	35		
979523789	CL 40-550/2/5.5A	5,5	10,2		55	54,5	54	53,5	53	52	51	48	45	42						
979520867	CL 40-600/2/5.5	5,5	10,6		59	58,9	57,9	57,4	56,5	56	55,5									
979523790	CL 40-625/2/7.5A	7,5	14,4		62	61,5	61	60	59	58	57	54	52,5	49						
979522080	CL 40-630/2/11.0	11	20,1		64,5	64,3	64	63,7	63,5	63	62,5	61,5	60,5	59	57,5	56	52,5	49		
979523791	CL 40-680/2/7.5A	7,5	14,4		67,5	67	66	65	64,5	63	61,5	59	56							
979523792	CL 40-830/2/11.0A	11	19,9		82	81,5	81	80,5	79,5	78,5	77,5	74	71	66,5						
979523793	CL 40-920/2/15.0A	15	26,8		92	91,5	90,5	90	89	88,5	87,3	84,5	82	76						

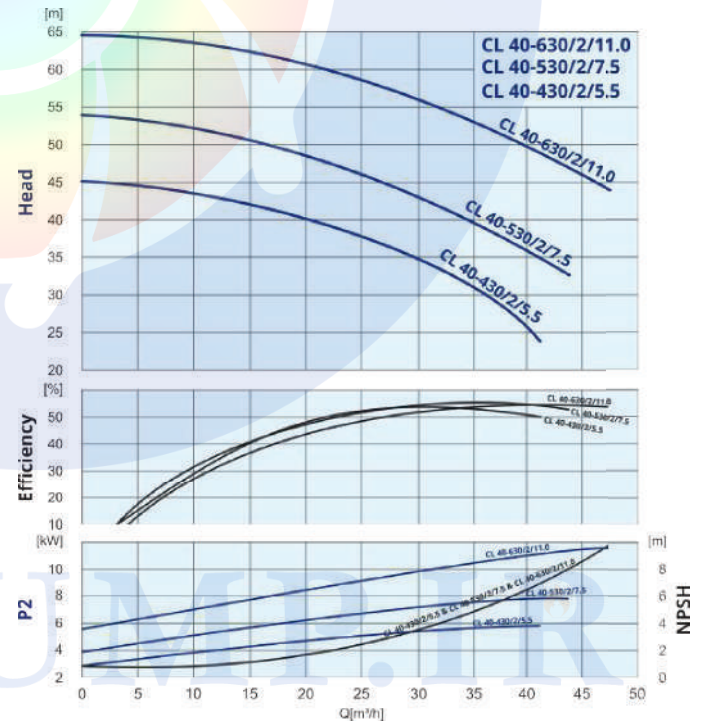
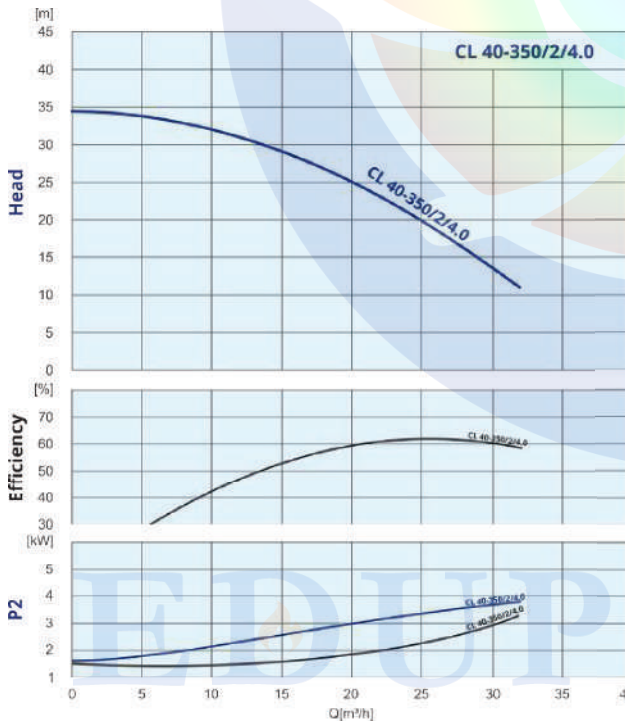
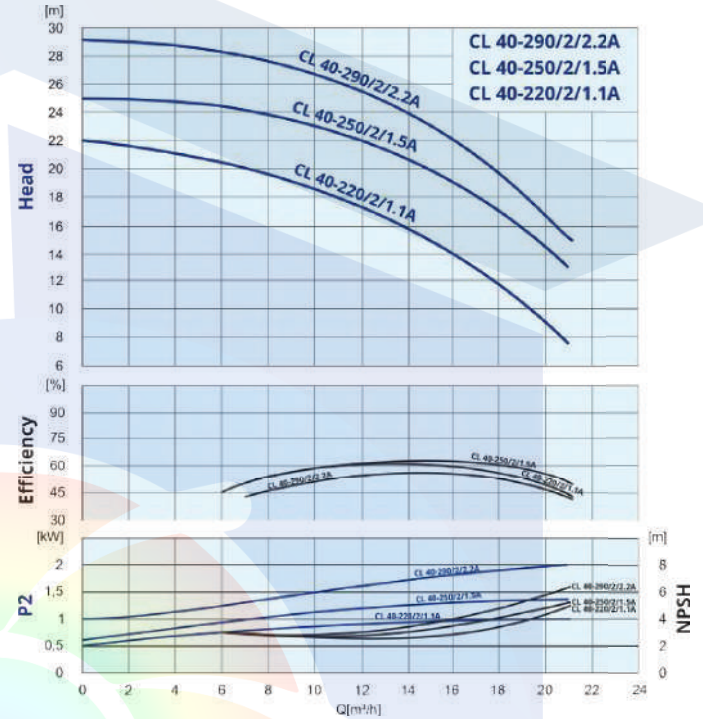
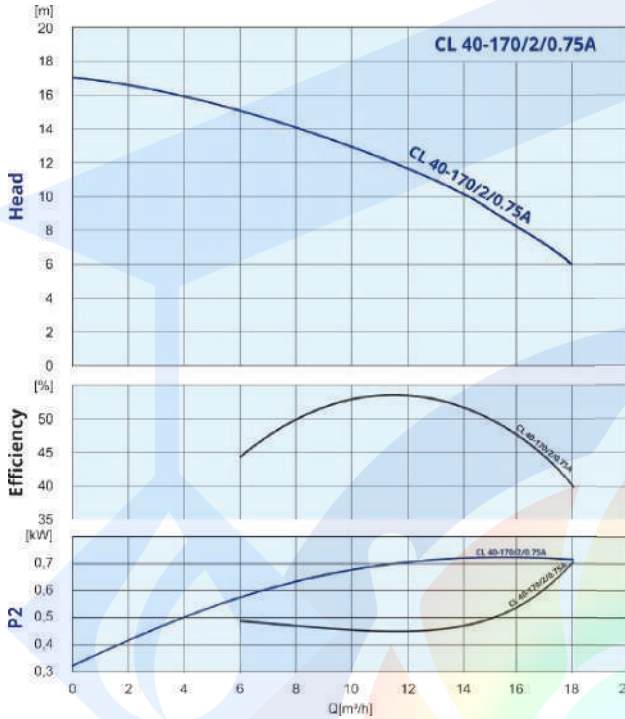

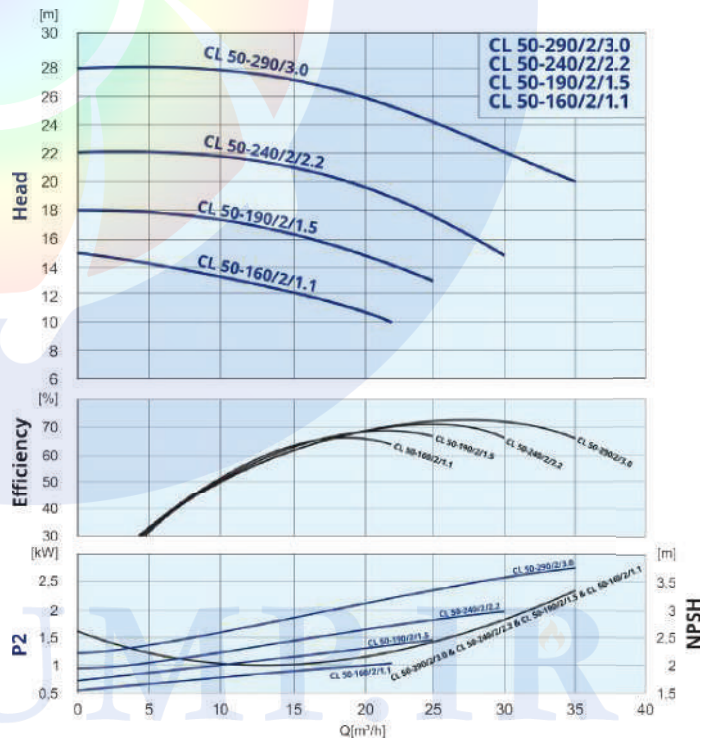
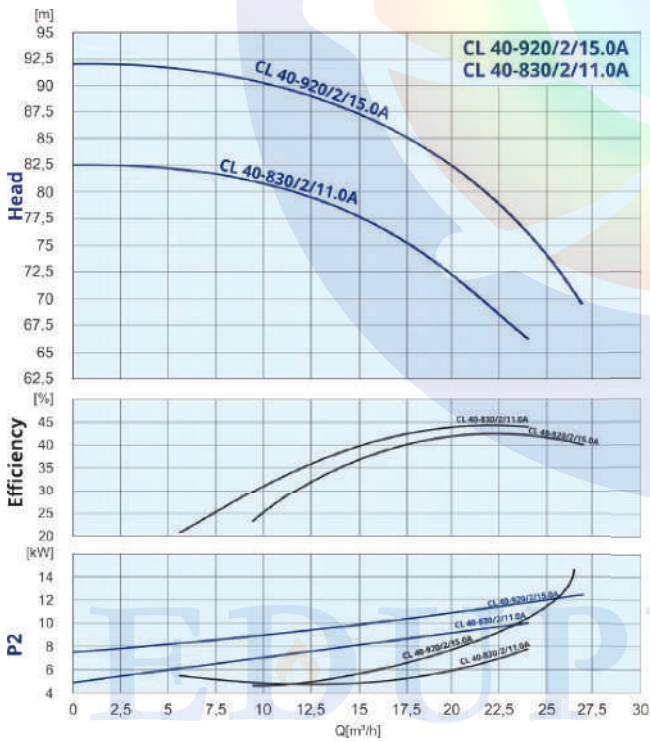
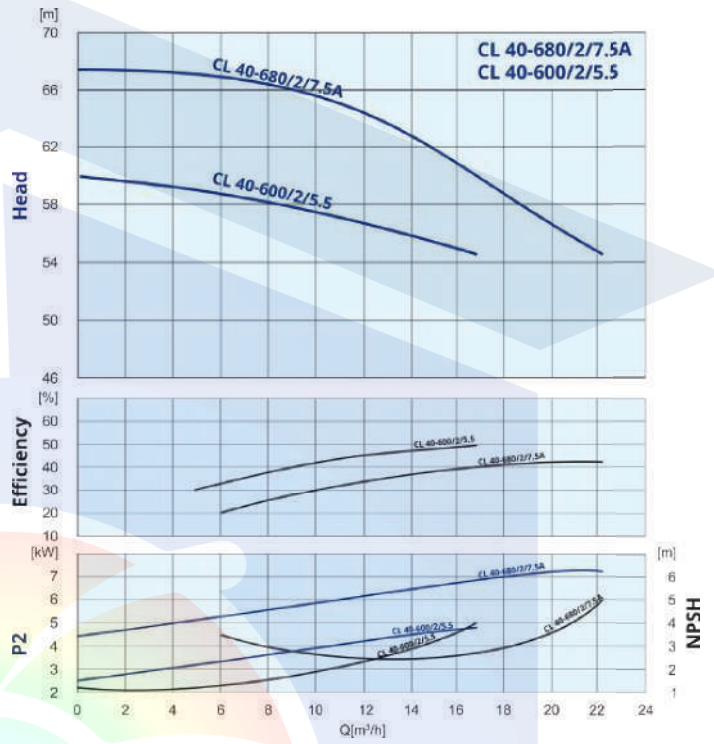
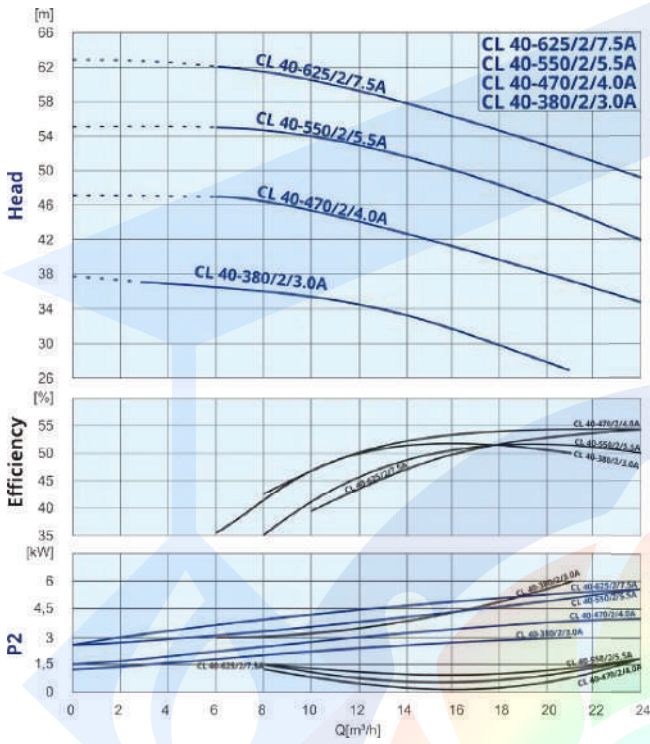

CL 2 poles - Dimensions

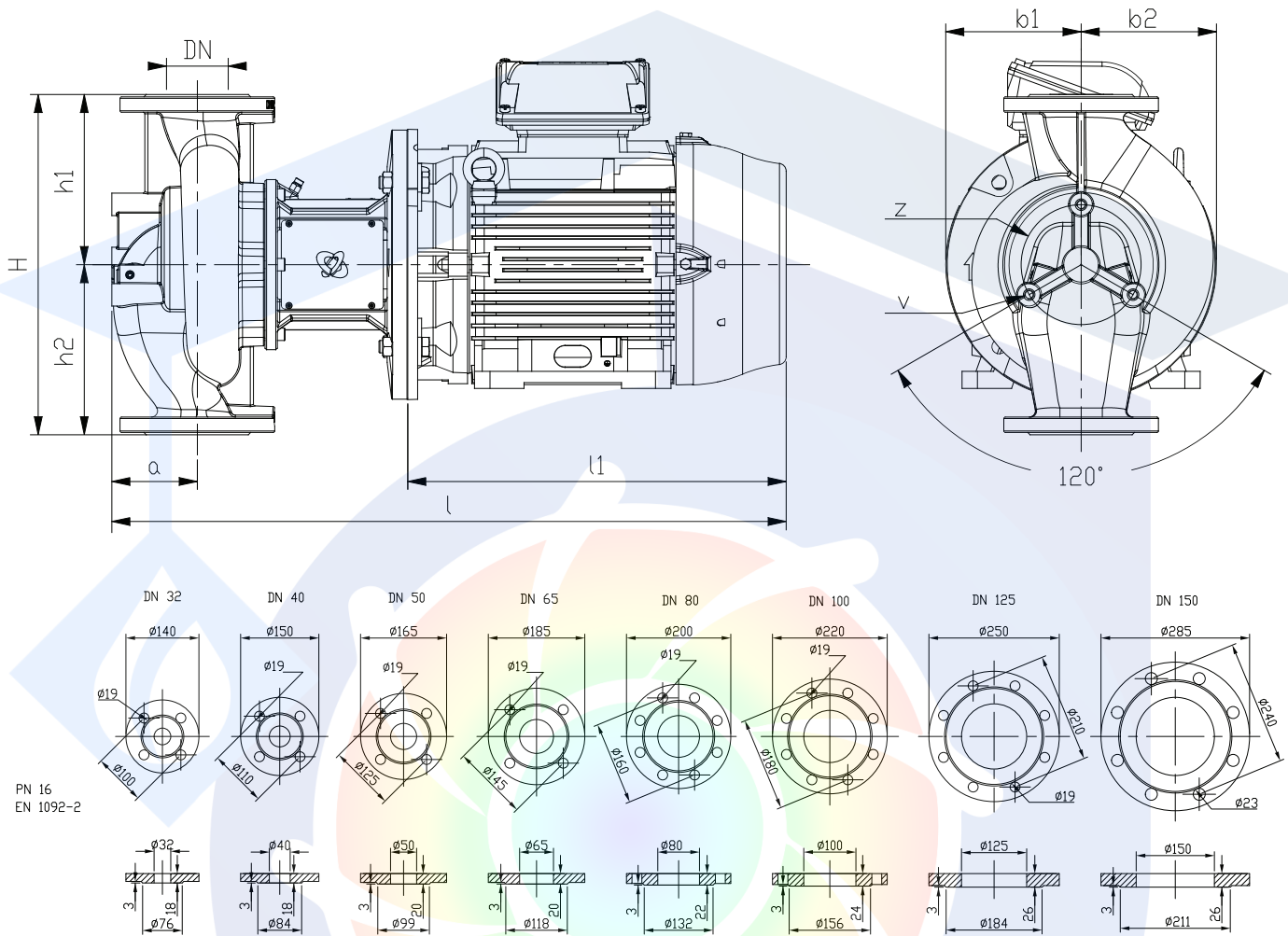

CL 2 poles DN40F

Code	Type	H	h1	h2	DN	a	l	l1	b1	b2	z	v	PN	Kg
979525070	CL 40-170/2/0.75A	300	140	160	40	100	446	/	93	129	/	/	10	26
979523782	CL 40-220/2/1.1A	300	140	160	40	100	446	/	93	129	/	/	10	27
979523783	CL 40-250/2/1.5A	300	140	160	40	100	446	/	93	129	/	/	10	29
979523784	CL 40-290/2/2.2A	320	150	170	40	100	481	/	108	138	/	/	10	31
979520868	CL 40-350/2/4.0	360	180	180	40	90	559	314	133	127	/	/	16	70
979523786	CL 40-380/2/3.0A	320	150	170	40	100	520	/	108	145	/	/	10	42
979522078	CL 40-430/2/5.5	440	220	220	40	106	700	371	164	164	142	M12x35	16	113
979523787	CL 40-470/2/4.0A	380	180	200	40	100	520	/	127	145	/	/	10	50
979522079	CL 40-530/2/7.5	440	220	220	40	106	700	371	164	164	142	M12x35	16	122
979523789	CL 40-550/2/5.5A	380	180	200	40	100	542	/	127	160	/	/	10	57
979520867	CL 40-600/2/5.5	390	190	200	40	90	639	361	145	135	/	/	16	76
979523790	CL 40-625/2/7.5A	380	180	200	40	100	564	/	127	160	/	/	10	60
979522080	CL 40-630/2/11.0	440	220	220	40	106	848,5	489,5	177	177	142	M12x35	16	177
979523791	CL 40-680/2/7.5A	440	210	230	40	100	584	/	165	160	/	/	10	57
979523792	CL 40-830/2/11.0A	440	210	230	40	100	659	/	165	194	/	/	10	80
979523793	CL 40-920/2/15.0A	440	210	230	40	100	710	/	165	194	/	/	10	84



EDUPUMP
WWW.EDUPUMP.IR

اولین و بزرگترین

سایت تخصصی سیستم‌های پمپاژ
با امکان محاسبه آنلاین و انتخاب پمپ

تولید بوستر پمپ آتش نشانی

در کلاس‌های S3 - S2 - S1
مورد تایید سازمان آتش نشانی تهران



اولین و بزرگترین مرجع انتخاب آنلاین سیستم‌های پمپاژ

انتخاب آنلاین انواع بوستر پمپ

انتخاب آنلاین انواع پمپ

ارائه مطالب تخصصی

اولین سایت مرجع

انتخاب آنلاین پمپ

در حوزه‌های:

ایمنی و آتش نشانی
آب و فاضلاب
صنایع غذایی
استخر
صنعت
معدن



تولید بوستر پمپ

آبرسانی دور متغیر

بدون محدودیت برند



آموزش

تهویه و تخلیه دود
سیستم‌های پمپاژ
ایمنی معماری
اطفاء حریق
اعلام حریق

مشاوره - طراحی - اجراء

تاسیسات مکانیکی (موتورخانه - استخر)
تهویه و تخلیه دود
سیستم‌های پمپاژ
ایمنی معماری
اعلام حریق
اطفاء حریق

تهران، سعدی شمالی، خیابان مرادی نور، پلاک ۳۱

تلفن: ۰۲۱-۷۷۶۸۶۹۶۶ فکس: ۰۲۱-۷۷۶۷۸۶۵۹

EDUPUMP.IR

WWW.EDUPUMP.IR