

پیشگامان صنعت و ایمنی پرگاس

PISHGAMAN SANAAT & IMENI PERGAS



طراح، مشاور و مجری سیستم‌های ایمنی و تاسیساتی

دارای صلاحیت سازمان آتش‌نشانی تهران

اخذ تاییدیه آتش‌نشانی

برای اطلاعات بیشتر اسکن کنید



تهران . خیابان سعدی شمالی . خیابان

شهید هرادى نور . پلاک ۳۱ . واحد ۱



WWW.PERGAS-CO.IR



INFO@PERGAS-CO.IR



۷۷۶۸۶۹۶۶



۷۷۶۷۸۶۵۹



3D SERIES

CENTRIFUGAL PUMPS CLOSE COUPLED AND STANDARDIZED EN 733

Centrifugal pumps close coupled (3D) and standardized EN 733 (3DS-3DP) in cast iron.

APPLICATIONS

- Water and clean liquids not chemically aggressive handling
- Water supply
- Pressure boosting
- Washing and industrial plants
- Water circulation in air-conditioning systems
- Irrigation and agriculture

TECHNICAL DETAILS

- Highly resistant construction
- Impeller in stainless steel
- High efficiency

PUMP TECHNICAL DATA

- Maximum working pressure: 10 bar
 - Temperature of the liquid:
 - 5°C ÷ +90°C
 - 5°C ÷ +110°C (H-HS-HW-HSW versions)
 - 5°C ÷ +120°C (E version)
 - MEI > 0,4 for 3D(.) SERIES 2 poles, MEI > 0,1 for 3D(.) SERIES 4 poles
- For further information please see our Data Book on the web site www.ebara-europe.com

MOTOR TECHNICAL DATA

- High efficiency IE2 motors starting from 0,75kW
- High efficiency IE3 motors starting from 7,5kW up to 22kW
- Self-ventilated 2 and 4 poles asynchronous motor
- Insulation class F (B for high temperatures)
- Protection degree IP 55
- 230V ±10% single phase voltage 50Hz,
- 230/400 ±10% (up to 4kW included) three phase 50Hz,
- 400/690V ±10% (from 5,5 kW and above) three phase 50Hz
- Protection is user's responsibility

MATERIALS

- Pump casing in cast iron EN-GJL-250-EN 1561
- Impeller in:
 - AISI 304 for 3D(.) SERIES 32, 40, 50
 - AISI 316 microcasted for 3D(.) SERIES 65
- Shaft in AISI 304 (part in contact with the liquid)
- Mechanical seal in:
 - Ceramic/Carbon/NBR (standard)
 - Ceramic/Carbon/FPM (H version)
 - SiC/SiC/FPM (HS version)
 - Tungsten Carbide/Tungsten Carbide/FPM (HW version)
 - SiC/Tungsten Carbide/FPM (HSW version)
 - Ceramic/Carbon/EPDM (E version)

SPECIAL VERSIONS

- Special voltages
- Special mechanical seals

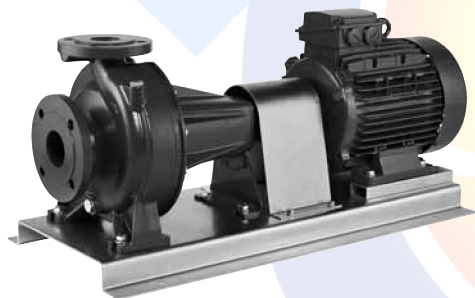
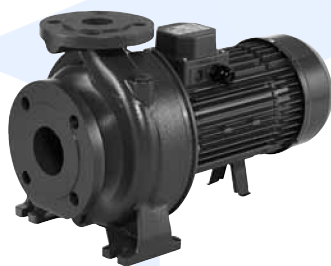

Available in 3 different versions with 2 and 4 pole motors

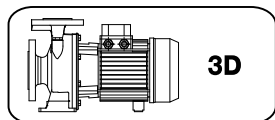

3D

Monobloc with extended motor shaft

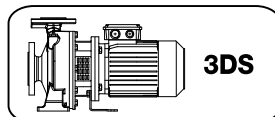

3DS

Monobloc with standard motor and rigid joint

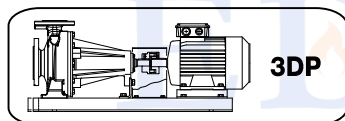

3DP

On base, with standard motor and flexible coupling



3D SERIES

CENTRIFUGAL PUMPS CLOSE COUPLED AND STANDARDIZED EN 733

PERFORMANCE CHART at 2900 min⁻¹ (according to ISO 9906 Attachment A)

2 Poles

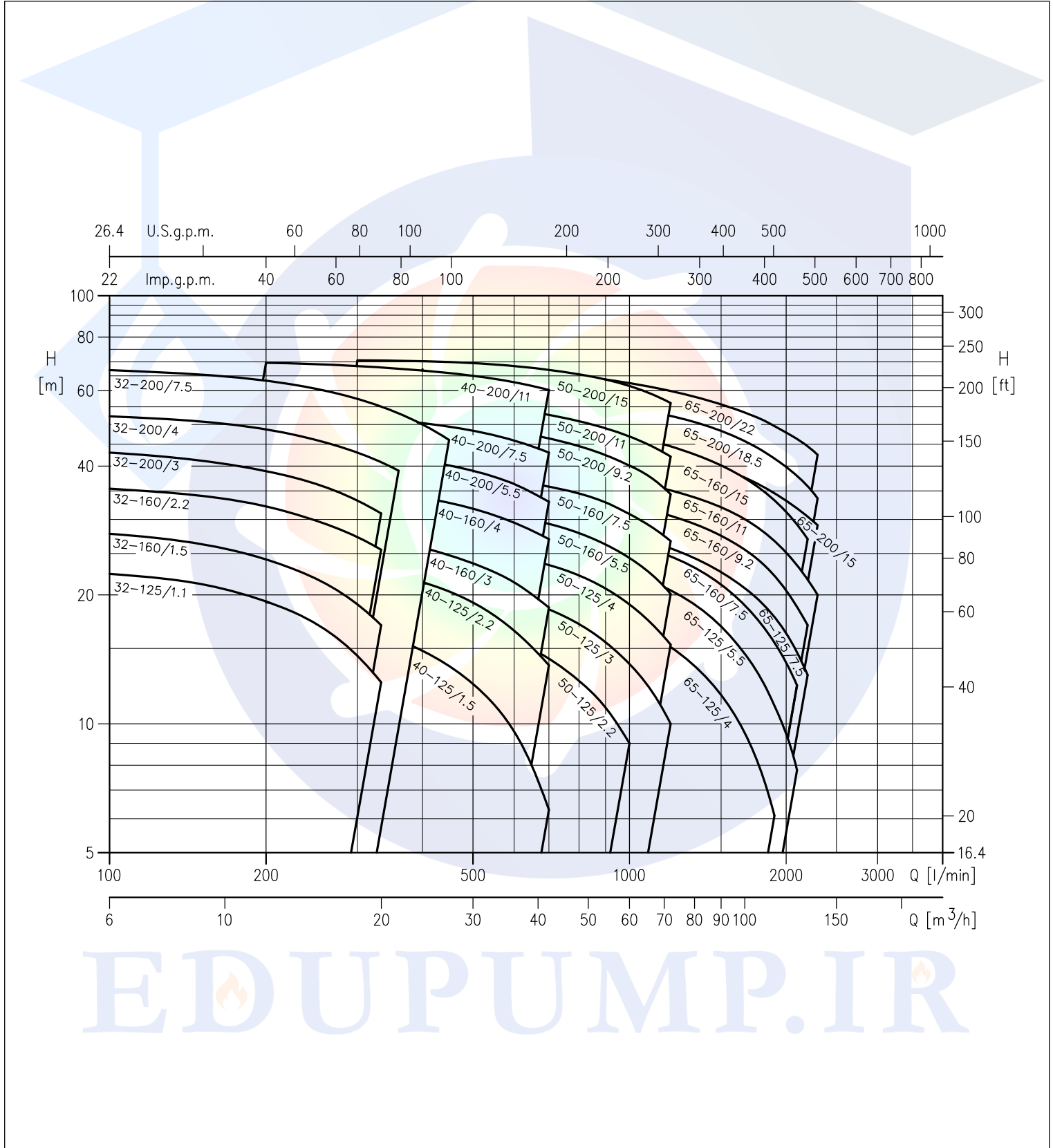

The contents of this publication must not be regarded as binding. EBARA Pumps Europe S.p.A. reserves the right to effect any modification it deems necessary, without prior notice.

3D SERIES

CENTRIFUGAL PUMPS CLOSE COUPLED AND STANDARDIZED EN 733

PERFORMANCE TABLE 3D(.) SERIES 32

2 Poles

Model	P ₂		Q=Flow rate									
	[HP]	[kW]	l/min	100	150	200	250	300	333	360	400	450
			m ³ /h	6	9	12	15	18	20	21,6	24	27
			H=Head [m]									
3D(.) 32-125/1.1 (M)	1,5	1,1	22,4	21,2	19,3	17,1	14,4	12,5	-	-	-	-
3D(.) 32-160/1.5 (M)	2	1,5	27,5	25,9	23,7	21,3	18,5	16,4	-	-	-	-
3D(.) 32-160/2.2 (M)	3	2,2	35,4	34,1	32,2	29,8	27,3	25,5	-	-	-	-
3D(.) 32-200/3.0	4	3	43,0	41,0	39,0	36,5	33,0	31,0	-	-	-	-
3D(.) 32-200/4.0	5,5	4	52,5	51,0	49,0	46,0	43,0	41,0	39,0	-	-	-
3D(.) 32-200/7.5	10	7,5	67,0	65,0	63,0	61,0	57,0	55,0	53,0	50,0	46,0	-

PERFORMANCE TABLE 3D(.) SERIES 40

2 Poles

Model	P ₂		Q=Flow rate									
	[HP]	[kW]	l/min	200	250	300	350	400	450	500	600	700
			m ³ /h	12	15	18	21	24	27	30	36	42
			H=Head [m]									
3D(.) 40-125/1.5 (M)	2	1,5	18,2	17,6	16,8	15,9	14,8	13,7	12,4	9,6	6,3	-
3D(.) 40-125/2.2 (M)	3	2,2	24,4	23,9	23,2	22,4	21,4	20,4	19,2	16,5	13,7	-
3D(.) 40-160/3.0	4	3	29,4	28,7	27,8	26,8	25,8	24,8	23,7	21,4	18,7	-
3D(.) 40-160/4.0	5,5	4	37,2	36,5	35,7	34,8	33,8	32,8	31,8	29,5	27,0	-
3D(.) 40-200/5.5	7,5	5,5	44,5	44,0	43,0	42,0	41,0	40,0	39,0	36,3	33,0	-
3D(.) 40-200/7.5	10	7,5	53,5	53,0	52,0	51,5	50,5	49,5	48,5	46,0	43,0	-
3D(.) 40-200/11	15	11	70,0	69,0	68,5	67,5	67,0	66,0	65,0	63,0	60,0	-

PERFORMANCE TABLE 3D(.) SERIES 50

2 Poles

Model	P ₂		Q=Flow rate									
	[HP]	[kW]	l/min	400	500	600	700	800	900	1000	1100	1200
			m ³ /h	24	30	36	42	48	54	60	66	72
			H=Head [m]									
3D(.) 50-125/2.2 (M)	3	2,2	18,0	17,0	15,7	14,2	12,6	10,9	9,0	-	-	-
3D(.) 50-125/3.0	4	3	21,5	20,8	19,8	18,5	17,1	15,5	13,8	12,0	10,0	-
3D(.) 50-125/4.0	5,5	4	25,8	25,3	24,5	23,5	22,2	20,7	19,0	17,2	15,3	-
3D(.) 50-160/5.5	7,5	5,5	32,0	31,5	30,5	29,3	27,9	26,2	24,4	22,4	20,0	-
3D(.) 50-160/7.5	10	7,5	38,2	37,6	36,9	35,8	34,5	32,9	30,9	28,9	26,7	-
3D(.) 50-200/9.2	12,5	9,2	-	49,5	48,0	46,5	44,5	42,5	40,0	37,6	34,4	-
3D(.) 50-200/11	15	11	-	55,5	54,5	52,5	51,0	49,0	47,0	44,5	42,0	-
3D(.) 50-200/15	20	15	-	69,5	68,5	67,0	65,5	63,5	61,5	59,0	56,0	-

PERFORMANCE TABLE 3D(.) SERIES 65

2 Poles

Model	P ₂		Q=Flow rate									
	[HP]	[kW]	l/min	600	700	1000	1300	1600	1900	2100	2200	2300
			m ³ /h	36	42	60	78	96	114	126	132	138
			H=Head [m]									
3D(.) 65-125/4.0	5,5	4	20,4	19,8	17,2	14,0	10,4	6,0	-	-	-	-
3D(.) 65-125/5.5	7,5	5,5	-	25,0	22,5	19,4	15,5	11,0	8,0	-	-	-
3D(.) 65-125/7.5	10	7,5	-	29,6	27,5	24,7	21,5	17,8	14,7	13,0	-	-
3D(.) 65-160/7.5	10	7,5	-	29,0	26,6	23,5	19,8	15,5	12,3	-	-	-
3D(.) 65-160/9.2	12,5	9,2	-	34,7	32,4	29,6	26,3	22,2	18,8	17,0	-	-
3D(.) 65-160/11	15	11	-	39,0	37,0	34,0	31,0	27,0	23,0	22,0	20,0	-
3D(.) 65-160/15	20	15	-	46,0	44,0	41,5	38,4	34,6	31,9	30,5	29,0v	-
3D(.) 65-200/15	20	15	-	51,0	47,0	43,0	38,6	33,3	29,2	27,0	-	-
3D(.) 65-200/18,5	25	18,5	-	58,0	55,0	51,0	47,0	41,5	37,9	35,9	33,6	-
3D(.) 65-200/22	30	22	-	65,5	62,5	58,5	54,5	49,5	46,0	44,5	42,5	-

(M) Single phase version only for 3D SERIES

The contents of this publication must not be regarded as binding. EBARA Pumps Europe S.p.A. reserves the right to effect any modification it deems necessary without prior notice.



3D SERIES

CENTRIFUGAL PUMPS CLOSE COUPLED AND STANDARDIZED EN 733

PERFORMANCE CURVES 3D(.) SERIES 50-125 at 2900 min⁻¹ (according to ISO 9906 Attachment A)

2 Poles

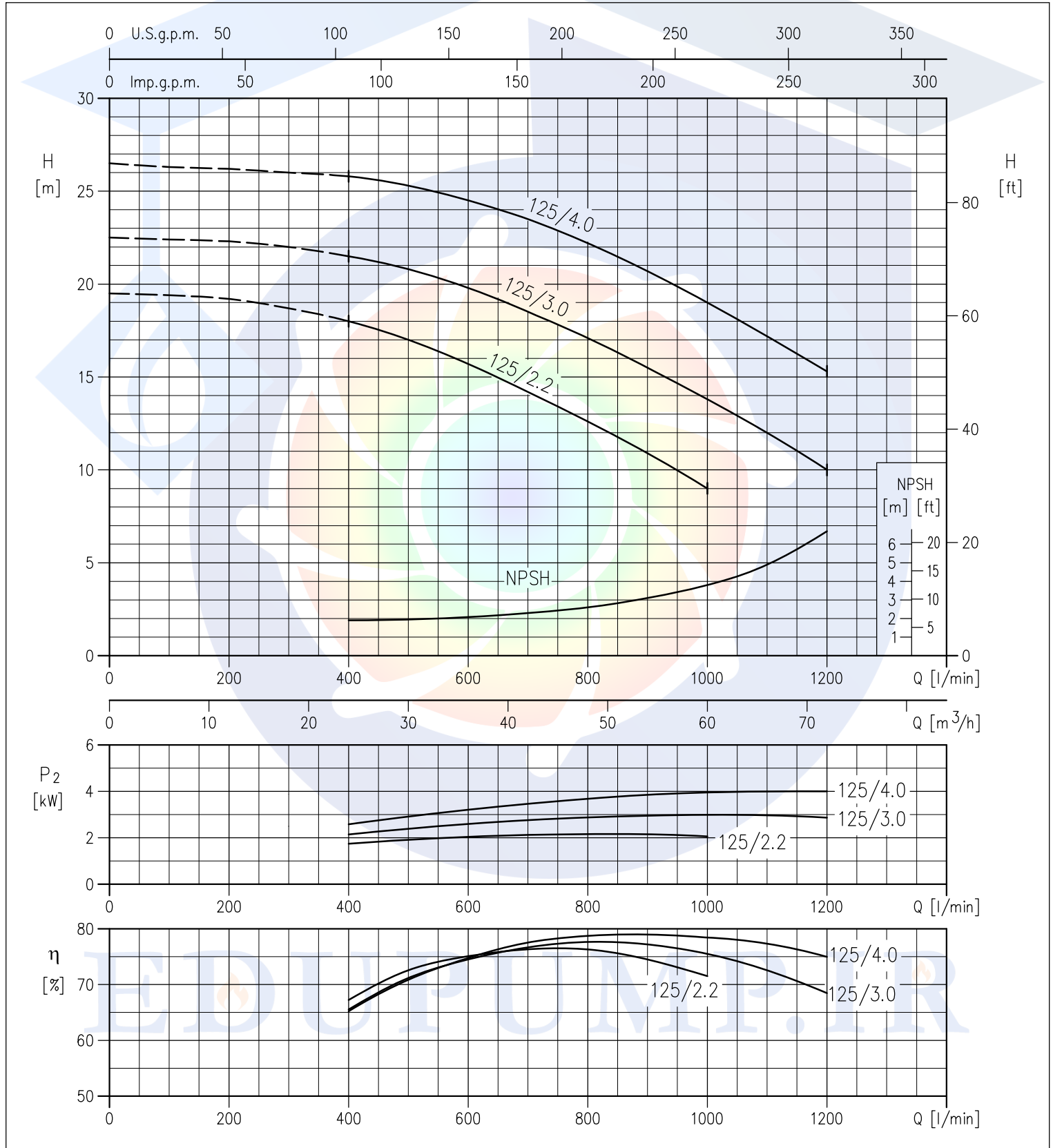

3D SERIES

CENTRIFUGAL PUMPS CLOSE COUPLED AND STANDARDIZED EN 733

DIMENSIONS 3D SERIES - up to 11kW

2 Poles

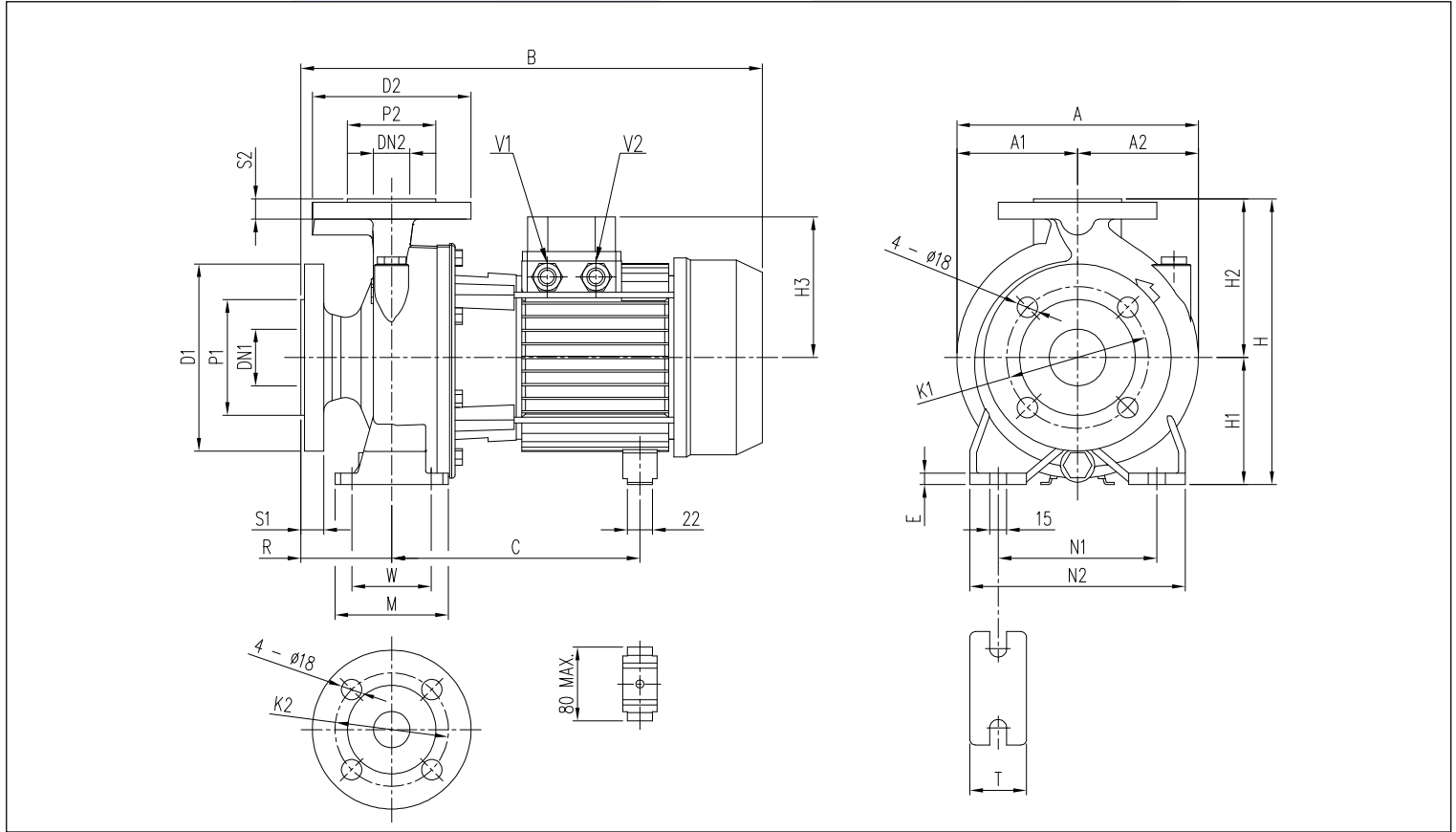

DIMENSIONAL TABLE

Model	Dimensions [mm]																												Weight [kg]								
	DN1 Ø	P1 Ø	K1 Ø	D1 Ø	S1	DN2 Ø	P2 Ø	K2 Ø	D2 Ø	S2	H	H1	H2	H3 [2]	[1]	R	W	M	N1	N2	T	E	A	A1	A2	B [2]	[1]	[*]	C [2]	[1]	V1 [1]	V2 [2]	[1]	[2]	[1]	[*]	
3D 32-125/1.1(M)	50	102	125	165	20	32	78	100	140	18	252	112	140	141	124	80	70	100	140	190	50	10	213	106,5	106,5	408	407	-	219±230	219±230	-	M20x1,5	PG13,5	25,0	29,5	-	
3D 32-160/1.5(M)	50	102	125	165	20	32	78	100	140	18	292	132	160	141	124	80	70	100	190	240	50	10	254	127	127	408	432	-	219±230	219±230	-	M20x1,5	PG13,5	29,0	33,5	-	
3D 32-160/2.2(M)	50	102	125	165	20	32	78	100	140	18	292	132	160	141	124	80	70	100	190	240	50	10	254	127	127	408	432	-	219±230	244±255	-	M20x1,5	PG13,5	35,7	36,0	-	
3D 32-200/3.0	50	102	125	165	20	32	78	100	140	18	340	160	180	-	124	80	70	100	190	240	50	10	296	148	148	-	471	-	-	244±255	-	-	PG13,5	-	47,5	-	-
3D 32-200/4.0	50	102	125	165	20	32	78	100	140	18	340	160	180	-	141	80	70	100	190	240	50	10	296	148	148	-	494	-	-	253	-	-	PG16	-	50,0	-	-
3D 32-200/7.5	50	102	125	165	20	32	78	100	140	18	340	160	180	-	150	80	70	100	190	240	50	10	296	148	148	-	519	539	-	275	PG13,5	-	PG16	-	62,0	65,1	-
3D 40-125/1.5(M)	65	122	145	185	20	40	88	110	150	18	252	112	140	141	124	80	70	100	160	210	50	10	220	108	112	408	407	-	219±230	219±230	-	M20x1,5	PG13,5	25,5	30,0	-	
3D 40-125/2.2(M)	65	122	145	185	20	40	88	110	150	18	292	132	160	-	124	80	70	100	190	240	50	12	254	127	127	-	471	-	-	244±255	-	-	PG13,5	-	31,7	32,0	-
3D 40-160/3.0	65	122	145	185	20	40	88	110	150	18	292	132	160	-	141	80	70	100	190	240	50	12	254	127	127	-	494	-	-	253	-	-	PG16	-	48,0	-	-
3D 40-160/4.0	65	122	145	185	20	40	88	110	150	18	292	132	160	-	141	80	70	100	190	240	50	12	254	127	127	-	494	-	-	253	-	-	PG16	-	48,0	-	-
3D 40-200/5.5	65	122	145	185	20	40	88	110	150	18	340	160	180	-	150	100	70	100	212	265	50	12	296	148	148	-	539	-	-	275	PG13,5	-	PG16	-	60,0	-	-
3D 40-200/7.5	65	122	145	185	20	40	88	110	150	18	340	160	180	-	150	100	70	100	212	265	50	12	296	148	148	-	539	559	-	275	PG13,5	-	PG16	-	63,0	66,1	-
3D 40-200/11	65	122	145	185	20	40	88	110	150	18	340	160	180	-	178	100	70	100	212	265	50	12	296	148	148	-	595	-	-	359	PG13,5	-	PG21	-	80,0	82,4	-
3D 50-125/2.2(M)	65	122	145	185	20	50	102	125	165	20	292	132	160	141	124	100	70	100	190	240	50	10	254	127	127	428	452	-	219±230	244±255	-	M20x1,5	PG13,5	34,4	37,0	-	
3D 50-125/3.0	65	122	145	185	20	50	102	125	165	20	292	132	160	-	124	100	70	100	190	240	50	10	254	127	127	-	491	-	-	244±255	-	-	PG13,5	-	39,5	-	-
3D 50-125/4.0	65	122	145	185	20	50	102	125	165	20	292	132	160	-	141	100	70	100	190	240	50	10	254	127	127	-	514	-	-	253	-	-	PG16	-	48,0	-	-
3D 50-160/5.5	65	122	145	185	20	50	102	125	165	20	340	160	180	-	150	100	70	100	212	265	50	10	296	148	148	-	539	-	-	275	PG13,5	-	PG16	-	60,0	-	-
3D 50-160/7.5	65	122	145	185	20	50	102	125	165	20	340	160	180	-	150	100	70	100	212	265	50	10	296	148	148	-	539	559	-	275	PG13,5	-	PG16	-	64,0	67,1	-
3D 50-200/9.2	65	122	145	185	20	50	102	125	165	20	360	160	200	-	178	100	70	100	212	265	50	10	296	148	148	-	595	-	-	359	PG13,5	-	PG21	-	77,0	77	-
3D 50-200/11	65	122	145	185	20	50	102	125	165	20	360	160	200	-	178	100	70	100	212	265	50	10	296	148	148	-	595	-	-	359	PG13,5	-	PG21	-	80,0	82,4	-
3D 65-125/4.0	80	138	160	200	22	65	122	145	185	20	340	160	180	-	141	100	95	125	212	280	65	12	263	127	136	-	514	-	-	253	-	-	PG16	-	53,0	-	-
3D 65-125/5.5	80	138	160	200	22	65	122	145	185	20	340	160	180	-	150	100	95	125	212	280	65	12	263	127	136	-	539	-	-	275	PG13,5	-	PG16	-	65,0	-	-
3D 65-125/7.5	80	138	160	200	22	65	122	145	185	20	340	160	180	-	150	100	95	125	212	280	65	12	263	127	136	-	539	559	-	275	PG13,5	-	PG16	-	69,5	72,6	-
3D 65-160/7.5	80	138	160	200	22	65	122	145	185	20	360	160	200	-	150	100	95	125	212	280	65	12	296	148	148	-	539	559	-	275	PG13,5	-	PG16	-	70,0	73,1	-
3D 65-160/9.2	80	138	160	200	22	65	122	145	185	20	360	160	200	-	178	100	95	125	212	280	65	12	296	148	148	-	595	-	-	359	PG13,5	-	PG21	-	85,0	85	-
3D 65-160/11	80	138	160	200	22	65	122	145	185	20	360	160	200	-	178	100	95	125	212	280	65	12	296	148	148	-	595	-	-	359	PG13,5	-	PG21	-	85,0	87,4	-

[1]= Three phase only [2]= Single phase only [*]= IE3 motors only

The contents of this publication must not be regarded as binding. EBARA Pumps Europe S.p.A. reserves the right to effect any modification it deems necessary, without prior notice.

شرکت پیشگامان صنعت و ایمنی پرگاس



گروه تخصصی اطفاء حریق

 Edufire.ir

 [Edufire.ir](https://www.instagram.com/Edufire.ir)



گروه تخصصی سیستم‌های پمپاژ

 Edupump.ir

 [Edupump.ir](https://www.instagram.com/Edupump.ir)



گروه تخصصی اعلان حریق

 Edualarm.ir

 [Edualarm.ir](https://www.instagram.com/Edualarm.ir)



گروه تخصصی تاسیسات مکانیکی

 Eduhvac.ir

 [Eduhvac.ir](https://www.instagram.com/Eduhvac.ir)

